

P1394.n
Draft Standard for a
High Performance Serial Bus
Peer-to-Peer Data Transfer Protocol (PPDT)

Sponsor

1394 Printer Working Group

Not yet Approved by

(an accredited standards organization)

Abstract:

Keywords:

Contents

	Page
1 Scope and purpose.....	1
1.1 Scope	1
1.2 Purpose.....	1
2 Normative references	3
2.1 Approved references.....	3
2.2 References under development.....	3
3 Definitions and notation	5
3.1 Definitions	5
3.1.1 Conformance definitions.....	5
3.1.2 Technical definitions	5
3.1.3 Abbreviations.....	8
3.2 Notation.....	8
3.2.1 Numeric values.....	8
3.2.2 Bit, byte and quadlet ordering.....	8
4 Model (informative)	11
4.1 Protocol stack and service model	11
4.2 Independent data paths for each service	12
4.3 Connection management.....	13
4.4 Data transfer between initiator and target.....	14
4.5 Control requests and responses	15
4.6 Unsolicited status	16
4.7 Reverse login	16
5 Data structures	19
5.1 Transport flow ORBs.....	19
5.2 Status block.....	20
5.3 Control information.....	22
5.4 Queue information.....	25
5.5 Reverse login request and response	26
6 Control operations.....	29
6.1 Login, reverse login and queue zero	29
6.2 Autonomous response information	30
6.3 Service discovery	31
6.4 Connection management.....	32
6.4.1 Connection establishment	32
6.4.2 Queue shutdown	33
6.5 Queue status information	36
7 Transport flow operations	37
7.1 Data transfer to a target	38
7.2 Data transfer to an initiator.....	39
7.3 Completion status	39
7.4 Execution context for active ORBs.....	40
7.5 Error recovery.....	40
8 Configuration ROM	43
8.1 Root directory	44
8.2 Instance directories	45
8.3 Feature directories	45

8.4 Keyword leaves	45
8.5 Unit directories	46
8.6 Device ID.....	48

Tables

Table 1 – Parameter ID values	24
Table 2 – Connection type encoded by queue ID parameters	32
Table 3 – Root directory entries	44
Table 4 – Feature directory entries	45
Table 5 – Recommended keywords.....	46
Table 6 – Unit directory entries	47

Figures

Figure 1 – Bit ordering within a byte.....	9
Figure 2 – Byte ordering within a quadlet.....	9
Figure 3 – Quadlet ordering within an octlet	9
Figure 4 – Protocol stack (service at target)	11
Figure 5 – Protocol stack (service at initiator).....	11
Figure 6 – Multiplexed queues in an SBP-2 task set	12
Figure 7 – Independent queues (logical model)	13
Figure 8 – Control request originated by initiator	15
Figure 9 – Control request originated by target	16
Figure 10 – Transport flow ORB	19
Figure 11 – Status block format	21
Figure 12 – Control information format	22
Figure 13 – Immediate parameter format	24
Figure 14 – Variable-length parameter format	25
Figure 15 – Queue information format.....	25
Figure 16 – Queue information byte format	26
Figure 17 – Reverse login request / response format	26
Figure 18 – Transport flow (datagram model)	37
Figure 19 – Transport flow (stream model).....	37
Figure 20 – Transport flow (spanned datagram model).....	38
Figure 21 – Excess initiator data (datagram model)	38
Figure 22 – Excess target data (datagram model)	39
Figure 23 – Example configuration ROM hierarchy	43
Figure 24 – First five quadlets of configuration ROM	43
Figure E-1 – Example bus information block and root directory	57
Figure E-2 – Feature directory with service ID and device ID leaves	58
Figure E-3 – Unit directory for peer-to-peer data transport (PPDT) protocol target.....	59
Figure E-4 – Instance directory and keyword leaf for a scanner.....	60
Figure E-5 – Instance directory and keyword leaf for a multiple protocol printer	61

Annexes

Annex A (normative) Minimum Serial Bus node capabilities	49
Annex B (normative) Compliance with ANSI NCITS 325-1998	51
Annex C (normative) Control request and response parameters	53
Annex D (normative) Control and status registers.....	55
Annex E (informative) Configuration ROM	57

1 Scope and purpose

1.1 Scope

This is a full-use standard whose scope is the definition of a peer-to-peer data transport (PPDT) protocol between Serial Bus devices that implement ANSI NCITS 325-1998, Serial Bus Protocol 2. The facilities specified include, but are not limited to, the following:

- Device and service discovery. PPDT devices may use uniform discovery procedures to locate other PPDT devices on the same bus. These procedures are extensible to an interconnected net of buses, when specified by IEEE P1394.1, Draft Standard for Serial Bus to Serial Bus Bridges. Once other PPDT devices are identified, facilities are provided to permit client applications to discover services;
- Self-configurable (plug and play) binding of device drivers to PPDT devices in a dynamic environment where users are free to insert and remove devices at will; and
- Connection management. A PPDT device (either an SBP-2 initiator or target) may establish and manage uni- or bi-directional connections for data transfer with other PPDT devices. The connections may be blocking or nonblocking, dependent upon application requirements, and operate independently of each other.

Although the original impetus for the development of this standard came from participants knowledgeable about printers and printing, the work evolved and became relevant to any application that requires efficient, peer-to-peer transport of data between devices.

1.2 Purpose

Experience with SBP-2 has demonstrated its high efficiency for the confirmed transport of large quantities of data between two devices. For historical reasons, SBP-2 is tailored to an environment where one device is the initiator (client) and the other the target (server); this is not necessarily the most natural approach when client applications and their associated servers may be located within initiator, target or both.

This standard creates a new layer of protocol services based upon SBP-2 but that provides building blocks more suited to a peer-to-peer environment. Because SBP-2 is already widely implemented in operating systems, this standard leverages that effort in order to enhance the value of Serial Bus to devices in a wider range of operational circumstances. These include printers, facsimile devices, scanners (or multifunction devices that present some combination of these functions) when a computer is present—but it is also intended to address the peer-to-peer needs of devices to communicate with each other in the absence of a computer.

2 Normative references

The standards named in this section contain provisions which, through reference in this text, constitute provisions of this standard. At the time of publication, the editions indicated were valid. All standards are subject to revision; parties to agreements based on this standard are encouraged to investigate the possibility of applying the most recent editions of the standards indicated below.

Copies of the following documents can be obtained from ANSI:

Approved ANSI standards;

Approved and draft regional and international standards (ISO, IEC, CEN/CENELEC and ITUT); and

Approved and draft foreign standards (including BIS, JIS and DIN).

For further information, contact the ANSI Customer Service Department by telephone at (212) 642-4900, by FAX at (212) 302-1286 or *via* the world wide web at <http://www.ansi.org>.

Additional contact information for document availability is provided below as needed.

2.1 Approved references

The following approved ANSI, international and regional standards (ISO, IEC, CEN/CENELEC and ITUT) may be obtained from the international and regional organizations that control them.

ANSI NCITS 325-1998, American National Standard for Information Systems—Serial Bus Protocol 2 (SBP-2)

IEEE Std 1284-1994, Standard Signaling Method for a Bi-directional Parallel Peripheral Interface for Personal Computers

IEEE Std 1394-1995, Standard for a High Performance Serial Bus

ISO/IEC 9899:1990, Programming Languages—C

2.2 References under development

At the time of publication, the following referenced standards were under development.

IEEE P1212, Draft Standard for a Control and Status Register (CSR) Architecture for Microcomputer Buses

IEEE P1394a, Draft Standard for a High Performance Serial Bus (Supplement)

3 Definitions and notation

For the purposes of this standard, the following definitions, terms and notational conventions apply. IEEE Std 100-1992, The New IEEE Standard Dictionary of Electrical and Electronics Terms, should be consulted for terms not defined in this section.

3.1 Definitions

3.1.1 Conformance definitions

Several keywords are used to differentiate levels of requirements and optionality, as follows:

3.1.1.1 expected: A keyword used to describe the behavior of the hardware or software in the design models assumed by this standard. Other hardware and software design models may also be implemented.

3.1.1.2 ignored: A keyword that describes bits, bytes, quadlets, octlets or fields whose values are not checked by the recipient.

3.1.1.3 may: A keyword that indicates flexibility of choice with no implied preference.

3.1.1.4 reserved: A keyword used to describe objects—bits, bytes, quadlets, octlets and fields—or the code values assigned to these objects in cases where either the object or the code value is set aside for future standardization. Usage and interpretation may be specified by future extensions to this or other standards. A reserved object shall be zeroed or, upon development of a future standard, set to a value specified by such a standard. The recipient of a reserved object shall not check its value. The recipient of an object defined by this standard as other than reserved shall check its value and reject reserved code values.

3.1.1.5 shall: A keyword that indicates a mandatory requirement. Designers are required to implement all such mandatory requirements to assure interoperability with other products conforming to this standard.

3.1.1.6 should: A keyword that denotes flexibility of choice with a strongly preferred alternative. Equivalent to the phrase “is recommended.”

3.1.2 Technical definitions

The following terms are used in this standard:

3.1.2.1 active ORB: [From the perspective of an initiator, an ORB in the target's task set, i.e., an ORB for which completion status has yet to be stored at the initiator's *status FIFO*. From the perspective of a target, an ORB for which the target maintains execution context.](#)

3.1.2.2 byte: Eight bits of data.

3.1.2.3 connection: A queue or a pair of queue(s) that affords access to a service. A connection may be unidirectional or bi-directional; in the latter case, a connection may be blocking or nonblocking. Two queues are necessary to implement a bi-directional, nonblocking connection.

3.1.2.4 control information: Information exchanged between initiator and target whose format is defined by this standard. The format of control information is independent of the format of application data exchanged by client applications and services—but both control information and application data are transported by the same ORB methods.

3.1.2.5 control ORB: A transport flow whose *queue* field is zero; it is used to transfer request or response control information between initiator and target.

3.1.2.6 final ORB: A transport flow ORB whose *final* and *notify* bits are both one. An initiator uses a final ORB to indicate to a target that no subsequent ORBs with the same *queue* value will be signaled unless the queue number is reissued by the target in a future CONNECT control request or response.

3.1.2.7 function: A capability of the device expressed as a unit architecture (unit directory) with a single logical unit (LU zero).

3.1.2.8 initiator: A node that originates SBP-2 management requests, control operation and transport flow ORBs and signals them to a target for processing.

3.1.2.9 logical unit: The part of the unit architecture that provides access to one or more services. Devices compliant with this standard implement one logical unit with a LUN of zero.

3.1.2.10 login: The process by which an initiator obtains access to a target fetch agent. The target fetch agent and its CSRs provide a mechanism for an initiator to signal ORBs to the target.

3.1.2.11 management service: A mandatory service provided for each function; it executes control requests to establish or terminate connections to the other services of the function. The connection to this service is implicitly established as the result of an SBP-2 login.

3.1.2.12 node: An addressable device attached to Serial Bus.

3.1.2.13 octlet: Eight bytes, or 64 bits, of data.

3.1.2.14 operation request block: A data structure fetched from system memory by a target in order to execute the request encapsulated within it.

3.1.2.15 quadlet: Four bytes, or 32 bits, of data.

3.1.2.16 queue: An ordered set of ORBs within a task set that does not block with respect to other queues that are part of the same task set.

3.1.2.17 receive: When any form of this verb is used in the context of Serial Bus primary packets, it indicates that the packet is made available to the transaction or application layers, *i.e.*, layers above the link layer. Neither a packet repeated by the PHY nor a packet examined by the link is "received" by the node unless the preceding is also true.

3.1.2.18 register: A term used to describe quadlet-aligned addresses that may be read or written by Serial Bus transactions. In the context of this standard, the use of the term register does not imply a specific hardware implementation. For example, in the case of split transactions that permit sufficient time between the request and response subactions, the behavior of the register may be emulated by a processor.

3.1.2.19 request subaction: A packet transmitted by a node (the requester) that communicates a transaction code and optional data to another node (the responder) or nodes.

3.1.2.20 response subaction: A packet transmitted by a node (the responder) that communicates a response code and optional data to another node (the requester). A response subaction may consist of either an acknowledge packet or a response packet.

3.1.2.21 service: A protocol used to control an independently operable component of a function.

3.1.2.22 split transaction: A transaction that consists of a request subaction followed by a separate response subaction. Subactions are considered separate if ownership of the bus is relinquished between the two.

3.1.2.23 status block: A data structure which may be written to system memory by a target when an operation request block has been completed.

3.1.2.24 store: When any form of this verb is used in the context of data transferred by the target to the system memory of either an initiator or other device, it indicates both the use of Serial Bus write request subaction(s), quadlet or block, to place the data in system memory and the corresponding response subaction(s) that complete the write(s).

3.1.2.25 system memory: The portions of any node's memory that are directly addressable by a Serial Bus address and which accepts, at a minimum, quadlet read and write access. Computers are the most common example of nodes that might make system memory addressable from Serial Bus, but any node, including those usually thought of as peripheral devices, may have system memory.

3.1.2.26 target: A node that fetches SBP-2 management requests, control operation and transport flow ORBs from an initiator. In the case of control operation or transport flow requests, the ORBs are directed to the target's logical unit zero to be executed. A CSR Architecture unit is synonymous with a target.

3.1.2.27 task: A task is an organizing concept that represents the work to be done by a target to carry out a command encapsulated by an ORB. In order to perform a task, a target maintains context information for the task, which includes (but is not limited to) the command, parameters such as data transfer addresses and lengths, completion status and ordering relationships to other tasks. A task has a lifetime, which commences when the task is entered into the target's task set, proceeds through a period of execution by the target and finishes either when completion status is stored at the initiator or when completion may be deduced from other information. While a task is active, it makes use of both target resources and initiator resources.

3.1.2.28 task set: A group of tasks available for execution by a logical unit of a target. ANSI NCITS 325-1998 specifies some dependencies between individual tasks within the task set and this standard mandates others.

3.1.2.29 transaction: A Serial Bus request subaction and the corresponding response subaction. The request subaction transmits a transaction code (such as quadlet read, block write or lock); some request subactions include data as well as transaction codes. The response subaction is null for transactions with broadcast destination addresses or broadcast transaction codes; otherwise it returns completion status and possibly data.

3.1.2.30 unit: A component of a Serial Bus node that provides processing, memory, I/O or some other functionality. Once the node is initialized, the unit provides a CSR interface that is typically accessed by device driver software at an initiator. A node may have multiple units, which normally operate independently of each other. Within this standard, a unit is equivalent to a target.

3.1.2.31 unit architecture: The specification of the interface to and the services provided by a unit implemented within a Serial Bus node. This standard extends the unit architecture defined by ANSI NCITS 325-1998 to include mechanisms for peer-to-peer data transport.

3.1.2.32 unit attention: A state that a logical unit maintains while it has unsolicited status information to report to one or more logged-in initiators. A unit attention condition shall be created as described elsewhere in this standard or in the applicable command set- and device-dependent documents. A unit attention condition shall persist for a logged-in initiator until a) unsolicited status that reports the unit attention condition is successfully stored at the initiator or b) the initiator's login becomes invalid or is

released. Logical units may queue unit attention conditions; after the first unit attention condition is cleared, another unit attention condition may exist.

3.1.2.33 unsolicited status block: A status block whose *src* field is two; the meaning of the *ORB_offset_hi* and *ORB_offset_lo* fields is unspecified and the status block does not pertain to any particular ORB.

3.1.2.34 working set: The part of a task set that has been fetched from the initiator by the target and is available to the target in its local storage.

3.1.3 Abbreviations

The following are abbreviations that are used in this standard:

CSR	Control and status register
CRC	Cyclical redundancy checksum
EUI-64	Extended Unique Identifier, 64-bits
LUN	Logical unit number
ORB	Operation request block
SDU	Service data unit
SBP-2	ANSI NCITS 325-1998

3.2 Notation

The following conventions should be understood by the reader in order to comprehend this standard.

3.2.1 Numeric values

Decimal and hexadecimal numbers are used within this standard. By editorial convention, decimal numbers are most frequently used to represent quantities or counts. Addresses are uniformly represented by hexadecimal numbers, which are also used when the value represented has an underlying structure that is more apparent in a hexadecimal format than in a decimal format.

Decimal numbers are represented by Arabic numerals without subscripts or by their English names. Hexadecimal numbers are represented by digits from the character set 0 – 9 and A – F followed by the subscript 16. When the subscript is unnecessary to disambiguate the base of the number it may be omitted. For the sake of legibility, hexadecimal numbers are separated into groups of four digits separated by spaces.

As an example, 42 and 2A₁₆ both represent the same numeric value.

3.2.2 Bit, byte and quadlet ordering

Devices compliant with this standard use the facilities of Serial Bus, IEEE Std 1394-1995; therefore this standard uses the ordering conventions of Serial Bus in the representation of data structures. In order to promote interoperability with memory buses that may have different ordering conventions, this standard defines the order and significance of bits within bytes, bytes within quadlets and quadlets within octlets in terms of their relative position and not their physically addressed position.

Within a byte, the most significant bit, *msb*, is that which is transmitted first and the least significant bit, *lsb*, is that which is transmitted last on Serial Bus, as illustrated below. The significance of the interior bits uniformly decreases in progression from *msb* to *lsb*.

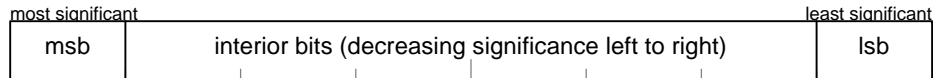

Figure 1 – Bit ordering within a byte

Within a quadlet, the most significant byte is that which is transmitted first and the least significant byte is that which is transmitted last on Serial Bus, as shown below.

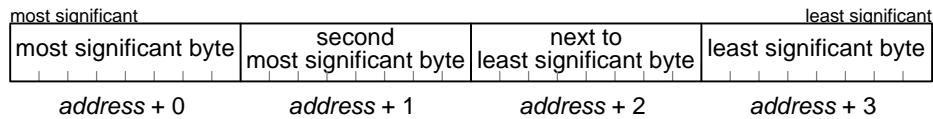

Figure 2 – Byte ordering within a quadlet

Within an octlet, which is frequently used to contain 64-bit Serial Bus addresses, the most significant quadlet is that which is transmitted first and the least significant quadlet is that which is transmitted last on Serial Bus, as the figure below indicates.

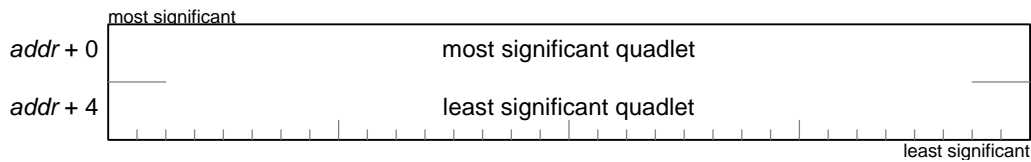

Figure 3 – Quadlet ordering within an octlet

When block transfers take place that are not quadlet aligned or not an integral number of quadlets. No assumptions can be made about the ordering (significance within a quadlet) of bytes at the unaligned beginning or fractional quadlet end of such a block transfer, unless an application has knowledge (outside of the scope of this standard) of the ordering conventions of the other bus.

4 Model (informative)

This section is informative and describes devices that conform to this document and its normative references. It is intended to enhance the usefulness of the other, normative parts of the document. In addition to the information in this clause, users of this document should also be familiar with the CSR architecture, Serial Bus standards and the ANSI NCITS 325-1998.

Examples of devices that come within the scope of this document include (but are not limited to) copiers, printers, facsimile machines, scanners and multi-function peripherals that combine two or more of these capabilities. These devices are characterized by high-volume transfers of application data; modest amounts of control information may be communicated in parallel with the application data transfers. These devices are used with diverse operating systems and application protocols; consequently any standard for their use with Serial Bus needs to hide many of the transport protocol details from the user applications. For example, a print driver that supports Postscript data formats should not be concerned with how data and control information are transported between it and the printer. This document resolves those concerns.

4.1 Protocol stack and service model

The relationship between the initiator and target may be modeled as a software stack present in both devices, as shown by Figure 4 and Figure 5 below. The physical interconnection, *via* Serial Bus, exists at the lowest protocol level. Logical connections (shown by dashed lines) exist at the other protocol levels: an SBP-2 login between the initiator and target multiplexes *queues* (defined by this document) that in turn support end-to-end *connections* (also defined by this document) between client applications and services. This document defines the data structures and methods necessary to implement the shaded levels in the protocol stacks, a peer-to-peer data transport (PPDT) based upon SBP-2. Note that client application(s) may reside at either the initiator or the target (they are commonly found at the initiator) and the service(s) at the corresponding SBP-2 functional role, target or initiator.

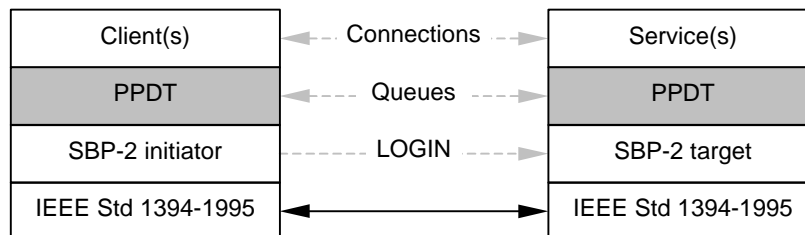

Figure 4 – Protocol stack (service at target)

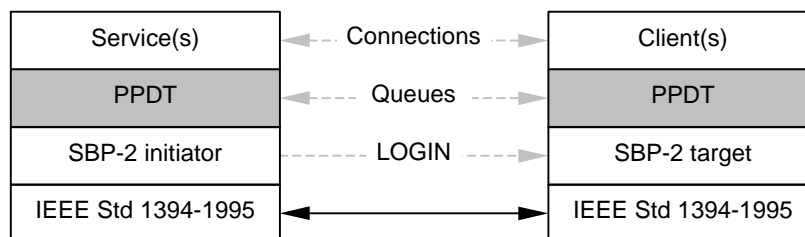

Figure 5 – Protocol stack (service at initiator)

In order for the application(s) and service(s) to communicate in a peer-to-peer, transport-independent manner, this document defines how SBP-2 may be used to implement uni- and bi-directional transport

flows for both control information and application data. Key concepts introduced below are used to explain the details of the transport flow model:

function: A capability of the device expressed as a unit architecture (unit directory) that contains a single logical unit (LU zero);

service: A protocol used to control an independently operable component of a function;

management service: A mandatory service provided for each function; it executes control requests to establish or terminate connections to the other services of the function. The connection to this function is implicitly established as the result of an SBP-2 login;

queue: An ordered set of ORBs within a task set that does not block with respect to other queues that are part of the same task set; and

connection: A queue or a pair of queues that affords access to a service. A connection may be unidirectional or bi-directional; in the latter case, a connection may be blocking or nonblocking. Two queues are necessary to implement a bi-directional, nonblocking connection.

4.2 Independent data paths for each service

ANSI NCITS 325-1998 describes all the work to be performed by a particular logical unit as a *task set*, a collection of ORBs linked together as shown by Figure 6.

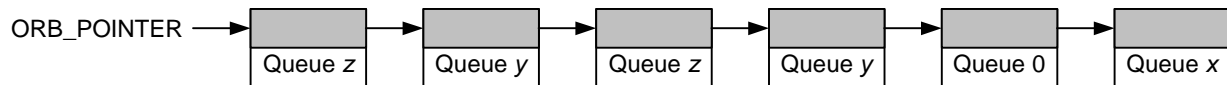

Figure 6 – Multiplexed queues in an SBP-2 task set

Because a single device **function** (logical unit) may be implemented as one or more **services** (protocols used to control independently operable components of a function), each of which may require an independent uni- or bi-directional transport flow, this document augments SBP-2 to permit multiplexed **queues** within a single task set, as illustrated by Figure 7. A queue is an ordered set of ORBs within a task set that does not block with respect to other queues that are part of the same task set; each ORB in the task set is labeled to identify the logical queue to which it belongs. Although the target may in general reorder the execution of ORBs within the task set, all of the ORBs within a particular queue are executed in order. Within this framework, both the initiator and the target manage the single task set illustrated above as the collection of logically independent queues illustrated below. The dashed lines connecting ORBs represent the logical ordering of ORBs within each queue, not the actual pointers that link ORBs in the task set.

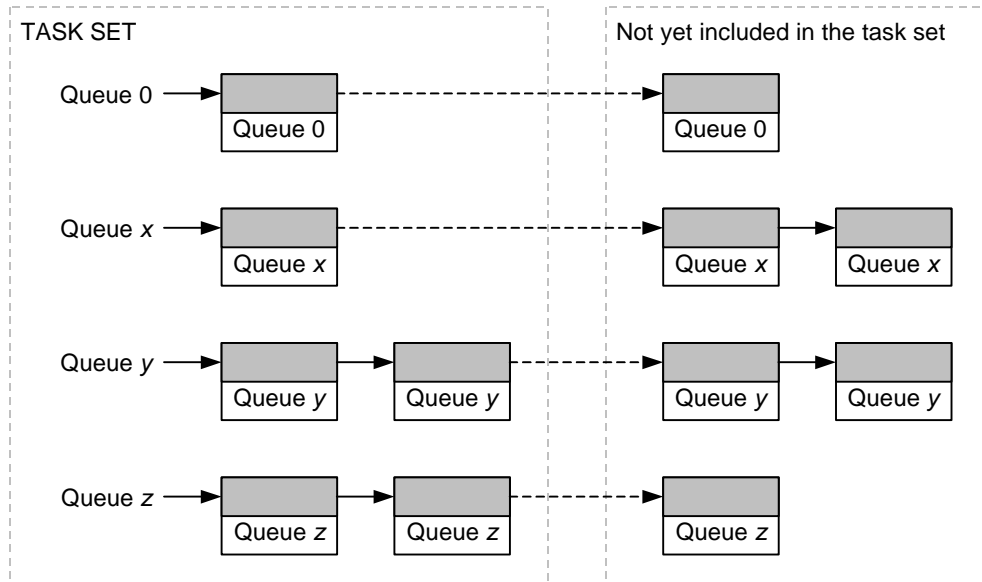

Figure 7 – Independent queues (logical model)

In theory the size of an SBP-2 task set is bounded only by the amount of memory available to the initiator to store ORBs; in practice targets have sufficient memory to fetch only a subset of the task set, the working set. Nonblocking behavior between the separate queues is achieved by restricting the size of the task set to that of the target's working set. If the initiator never places more ORBs in the task set than the target can accommodate in its working set, all outstanding ORBs may be fetched by the target and made available for execution. The initiator restricts the number of outstanding ORBs on a queue by queue basis so that a task slot in the working set is always available for each queue. Since the client application or service may initiate more data transfer requests than can be simultaneously active in the task set, the initiator marshals ORBs by queue number outside of the task set and enters them into the task set as task slots become available.

Because queues do not block with respect to each other, nonblocking bi-directional data transfer between initiator and target may be accomplished through the use of two queues, one for each direction.

4.3 Connection management

The multiplexed queue management scheme just described requires the allocation of target resources (queue numbers and task slots) before it may be used. Collectively these resources constitute a *connection* between a client and a service. This document defines methods by which connection(s) are established and subsequently terminated and their resources freed.

Connections may be established by either an initiator or a target. Because of asymmetries in SBP-2, the connection parameters differ dependent upon the source of the connection request—but at the transport-independent level perceived by clients and services the connection mechanisms are peer-to-peer and symmetric. When a client wishes to establish a connection with a particular service in the other device, it provides a *service ID*, a unique string that specifies the desired service. Service IDs are maintained in a separate registry and are assumed by this document to be well-known identifiers. If the specified service exists in the other device (along with sufficient resources for the connection), the connection is created and subsequently identified by the queue number(s) assigned to the connection.

Connections may be one of three different types:

- Unidirectional; the application data flow is one direction, either from the initiator to the target or *vice versa*;
- Bi-directional (nonblocking); the application data flows in both directions with one queue used for each of the directions; or
- Bi-directional (blocking); the data flows in both directions *via* a single queue which has the potential to block. Nonblocking behavior is not guaranteed by the transport but must be a property of the application itself. The queue used for management services is an example of a bi-directional, blocking queue, but because it is restricted to single-threaded, serialized use it cannot block.

Once a connection is established it persists across bus reset(s) until explicitly terminated or abandoned as a consequence of a logout.

Just as either initiator or target may establish a connection, either may terminate the connection regardless of which one created the connection. A disconnect may be synchronized with the transport flow in order to gracefully end the connection or it may preempt the transport flow if necessary. Once the disconnect is complete, the target resources (queue numbers and task slots) are available for reuse.

4.4 Data transfer between initiator and target

Once a connection is established, application data may be transferred between initiator and target. SBP-2 transport flow ORBs are used to regulate the data transfer: each ORB specifies the direction (from the target or to the target) and provides a buffer that is either the source or destination for the data. The target initiates all data transfer requests, which permits it to pace the data transfer rate according to the availability of its own resources. The initiator, on the other hand, makes all of the data (or a buffer to accommodate all of the data) accessible the whole time the ORB is executed.

Data transfer from the initiator to the target is straightforward: the initiator signals an ORB with the appropriate *direction* bit to the target and the target issues read requests to access the data. Data transfer in the opposite direction, from the target to the initiator, is more complex. Because the target may not signal an ORB to the initiator, it indicates to the initiator that data is available. In response, the initiator signals an ORB with an empty buffer to receive the data and the target issues write requests to store the data.

In both cases, ORB completion is indicated when the target stores a status block at the initiator. The status block may specify a residual count if all available data was not transferred. The status block also includes codes that describe successful or error completion of the data transfer described by the ORB. The status block does not indicate whether or not the data was successfully utilized by an application client or service—only whether or not the data was transferred across Serial Bus.

Data transfer between initiator and target is modeled either as a datagram or as a stream. When datagram mode is used, each service data unit (SDU) fits within a single buffer described by an ORB. If no SDU is available for transfer, the ORB may block and not be completed until an entire SDU is ready. Or, if the recipient is unable to accept the SDU (too small a buffer), no data is transferred and an error results. In contrast, stream mode permits data to flow as it becomes available. An ORB that transfers data to a target in stream mode cannot fail because the target's buffer is too small while an ORB that transfers stream data from a target may complete as soon as the first byte of data is available.¹ [In both cases, datagram or stream, circumstances may arise where ORBs are completed even though no data has been transferred.](#)

¹ Applications may defer completion of an ORB until some minimum amount of data has been transferred. This "watermark" capability may improve performance.

4.5 Control requests and responses

In order to coordinate the flow of application data between initiator and target, a set of control operations are defined. These operations take the form of a control request and a corresponding response; their functions include interrogation of [available](#) services ~~supported by the target~~, establishment of a connection, notification that target data is available for transfer to the initiator and confirmed release of queue resources upon disconnection. Either initiator or target may originate a control request; processing is single-threaded until a control response is returned.

Control requests and responses ~~are data transferred between initiator and target in exactly the same fashion as application data except that ORBs that describe control information are not encoded within ORBs themselves but are contained within data transferred between initiator and target buffers. ORBs that mediate the transfer of control information are no different from those used for application data except that they~~ specify predefined queue zero. This bi-directional, blocking queue is reserved solely for control requests and responses and is not available for the transfer of application data between initiator and target. Queue zero ([the control queue](#)) is automatically allocated as a result of successful login and may not be released by either initiator or target until logout.

If neither initiator nor target has an outstanding control request, queue zero is empty (*i.e.*, there are no ORBs in the task set that specify queue zero). The operational sequences differ dependent upon the originator of the control request, initiator or target, as illustrated below.

When the initiator originates a control request, it signals an ORB to the target that describes a buffer that contains the control request. The initiator subsequently signals another ORB to the target that describes a buffer available to receive the response. For the sake of efficiency, both ORBs may be linked and signaled to the target at the same time as illustrated by Figure 8.

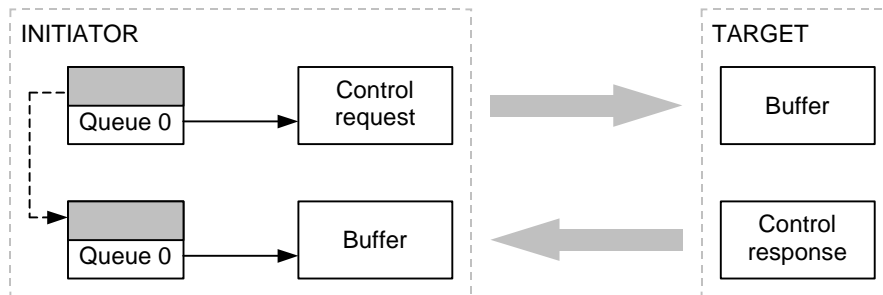

Figure 8 – Control request originated by initiator

In the figure above, the target fetches the control request from the initiator's buffer and then stores completion status at the initiator's *status_FIFO*. The control request itself is not necessarily executed at this point but it has been securely read by the target. After the request is executed, the target stores a control response in the buffer provided by the second ORB and then stores completion status for that ORB at the initiator's *status_FIFO*. Successful receipt of the control response permits the initiator to examine the response data to determine whether or not the request succeeded.

In the case where the target has a control request to make of the initiator, it first communicates to the initiator that a queue zero ORB is needed. This attention condition may be communicated by any status block, either one associated with the completion of application data transfer on a queue other than queue zero, a status block for a completed queue zero transfer or an unsolicited status transfer. The result is the same no matter what the source of the status block; this is illustrated by the upper portion of Figure 9.

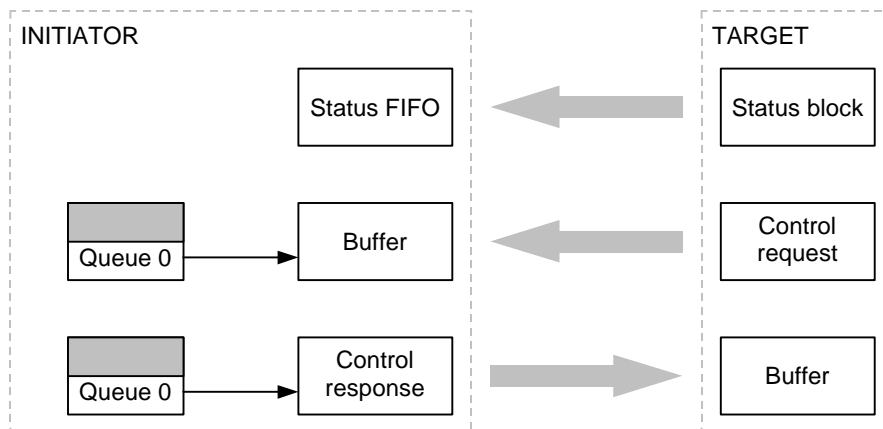

Figure 9 – Control request originated by target

In response to a status block that indicates an attention condition, the initiator signals an ORB to the target that describes a buffer available to receive the control request. Note that the initiator cannot signal an ORB for the response at the same time because the control response is not yet available. Once the target has transferred the control request to the initiator buffer, it stores completion status for the ORB at the initiator *status_FIFO*. Receipt of this status block permits the initiator to retrieve the control request, process it, prepare a control response and signal an ORB to the target that describes a buffer that contains the control response. After the target has read the control response, it stores completion status at the initiator *status_FIFO*.

When control requests are simultaneously available at both initiator and target, the order in which they are processed is arbitrary so long as request execution is single-threaded. An initiator may not originate a subsequent request if it detects a target attention condition during the current control request and response cycle.

4.6 Unsolicited status

As described above, a target communicates an attention condition to an initiator when the target has a control request [or autonomous response information](#) available. ~~For the sake of efficiency, the attention condition is often included in completion status for some soon to be completed ORB. If the target's task set is empty, there are no eligible ORBs and the time before the initiator signals a new ORB is indeterminate.~~ [An attention condition often exists or arises synchronously with the completion of a transport flow ORB, in which case it is indicated by the *attention* bit in the status block for that ORB. At other times, the occurrence of an attention condition is asynchronous.](#) In this case, the target may store an unsolicited status block at the initiator *status_FIFO*.

The essential nature of an unsolicited status block is that it is not associated with any ORB. As a consequence, it is useful only for information that is generic to the target (such as the attention condition) and useless to communicate more specific information (such as the state of a particular queue).

4.7 [Reverse login](#)

[The preceding clauses describe peer-to-peer operations between an initiator and a target once the target has granted a login requested by the initiator. This is the natural SBP-2 model and corresponds to the common situation where the client application \(e.g., a device driver\) is located at the initiator and the service is located at the target. When the situation is reversed and the target is the one to initiate operations, there is no corresponding SBP-2 login request from the target to the initiator.](#)

This standard defines a new facility, "reverse login", which permits a target to request an initiator to perform an SBP-2 login. The method is based on the MESSAGE_REQUEST register defined by draft standard IEEE P1212; initiators that support this facility are identified by entries in their configuration ROM.

5 Data structures

This document defines the format of those parts of the SBP-2 ORB and status block reserved by ANSI NCITS 325-1998 for specification by command set standards. It also defines a format for control information transferred between initiator and target. All data structures defined in the following clauses shall be aligned on quadlet boundaries.

5.1 Transport flow ORBs

ANSI NCITS 325-1998 defines command block ORBs for SBP-2 devices; these have a common 20-byte header and leave the definition of the subsequent quadlets to individual command set standards. Devices compliant with this standard shall use 32-byte command block ORBs (renamed transport flow ORBs to emphasize their function) whose format is illustrated by Figure 10. Transport flow ORBs are used to regulate the transfer of application data or control information between initiator and target.

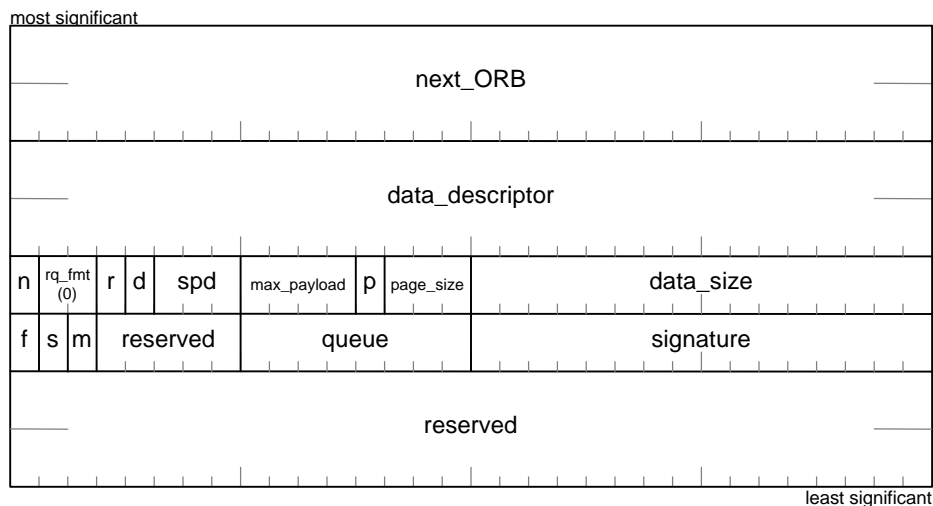

Figure 10 – Transport flow ORB

The usage of the *next_ORB*, *data_descriptor*, *rq_fmt*, *spd*, *max_payload*, *page_size* and *data_size* fields and the *notify* and *page_table_present* bits (abbreviated as *n* and *p*, respectively, in the figure above) is defined by ANSI NCITS 325-1998. The *rq_fmt* field shall be zero.

NOTE – For most SBP-2 implementations the *notify* bit should always be one so that the SBP-2 initiator software may accurately determine completion status for each ORB; this is a consequence of the unordered execution model. Other implementations that do not require completion status notification for each ORB may be possible if information is shared between the SBP-2 initiator and its client application(s) but the implementation details are beyond the scope of this document.

The *direction* bit (abbreviated as *d* in the figure above) shall specify the direction of data transfer for the buffer described by *data_descriptor*. If the *direction* bit is zero, the target shall use Serial Bus read transactions to fetch data from the buffer (the flow direction is from the initiator to the target). Otherwise, when the *direction* bit is one, the target shall use Serial Bus write transactions to store data in the buffer (the flow direction is from the target to the initiator).

NOTE – The direction of data transfer is determined solely by the *direction* bit without reference to the *queue* number. Unspecified behavior may occur if an ORB's *direction* bit does not match the expected data transfer direction for the queue.

The *final* bit (abbreviated as *f* in the figure above) shall be set to one to indicate that the initiator shall not signal any subsequent ORBs with the same *queue* value as this ORB until the target allocates the queue number in a future CONNECT request or response. Otherwise the value of *final* bit shall be zero and the initiator may continue to signal ORBs for the queue. When the *final* bit is one the *notify* bit shall also be one.

The *special* bit (abbreviated as *s* in the figure above) provides additional information pertinent to application data transferred from the initiator to the target. The meaning of the *special* bit is unspecified when either of the *data_size* or *queue* fields are zero or the *direction* bit is one. Otherwise the meaning and usage of the *special* bit are application-dependent and shall apply to all of the application data contained within the buffer described by the ORB.

NOTE – Stream socket abstractions include the notion of *out of band* data, as some transport protocols allow portions of incoming data to be marked as "special" in some way. These special data blocks may be delivered to the user out of the normal sequence—for example, expedited data in X.25 and other OSI protocols or the use of urgent data in TCP by BSD Unix. The *special* bit enables such usage to be mapped to a transport protocol based on SBP-2.

The *end_of_message* bit (abbreviated as *m* in the figure above) shall indicate whether or not a boundary exists in the application data or control information transferred from the initiator to the target. The meaning of the *end_of_message* bit is unspecified when the *direction* bit is one. Otherwise, when *end_of_message* is one, a boundary exists after the last byte of application data or control information described by the ORB. In the case of application data, the nature of the boundary and its interpretation shall be specified by the service definition. When the *queue* field is zero, the *end_of_message* bit shall also be one; all control information for a single request or response shall be contained within one buffer.

NOTE – When *end_of_message* is one and *data_size* is zero, a boundary exists at the end of application data or control information previously transferred to the target. The target flushes this data to the receiving application client and indicates the *end_of_message* condition.

The *queue* field shall specify either queue zero or a queue number assigned the target in either a CONNECT request or response (see 6.4.1). When the *queue* field is zero, the *final* bit shall be zero and the *notify* bit shall be one.

The *signature* field shall contain an identifying number assigned by the initiator and shall be unique within the context of a queue. Individual data buffers are uniquely identified by the combination of *queue* and *signature*. For a particular queue, an initiator shall not reuse a *signature* value until either the **connection queue** has been **reset shutdown** (see 6.4.2) or a status block has been received for a subsequent ORB in the same queue. This field is used to facilitate the resumption of data transfer after a bus reset or other transient interruption while minimizing retransmission of data securely stored prior to the interruption (see 7.5).

5.2 Status block

As described by ANSI NCITS 325-1998, a target may store status at an initiator *status_FIFO* address when a request completes (successfully or in error) or because of an unsolicited event (device status change). The *status_FIFO* address is obtained either explicitly from the ORB to which the status pertains or implicitly from the fetch agent context. Whenever the target has status to report and is enabled to do so, it shall store the status block illustrated by Figure 11.

Without regard to the value of the *notify* bit in the ORB to which status pertains, the target shall store completion status if any of the *dead*, *attention*, *target_data_pending*, *special* and *end_of_message* bits or either of the *status* and *residual* fields are nonzero.

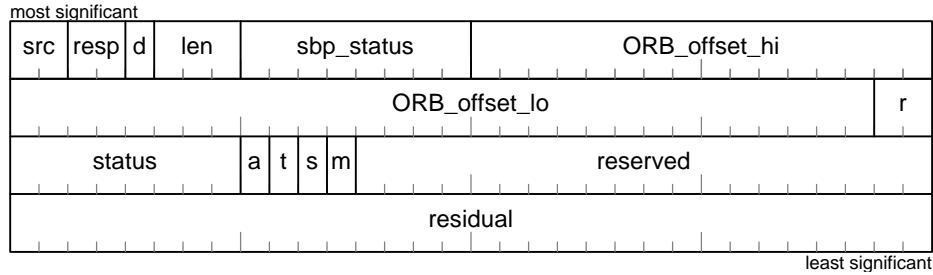

Figure 11 – Status block format

The definition and usage of the *src*, *resp*, *len*, *sbp_status*, *ORB_offset_hi* and *ORB_offset_lo* fields, as well as the *dead* bit (abbreviated as *d* in the figure above), are specified by ANSI NCITS 325-1998.

The *len* field shall have a value of three to indicate that the length of the status block is four quadlets.

The *status* field shall specify the completion status of the transport flow requested by the ORB, as encoded by the table below.

<i>status</i>	Description
0	The application data or control information has been successfully transferred; consult the <i>residual</i> field for details of the actual transfer length.
1	Invalid queue; the queue identified in the ORB has not been allocated to an active connection.
2	Target reset by another initiator; all tasks aborted.

The *attention* bit (abbreviated as *a* in the figure above) indicates the availability of target control information. When the *attention* bit is one, the initiator should post an ORB for queue zero to retrieve the control information. Once set to one by the target, this bit shall remain set until the initiator successfully retrieves the control information.

The *target_data_pending* bit (abbreviated as *t* in the figure above) indicates the availability of target application data for the queue specified by the ORB identified by *ORB_offset_hi* and *ORB_offset_lo*. When the *target_data_pending* bit is one, the initiator should post an ORB for the specified queue to retrieve the application data. The target shall zero this bit when there is no pending application data awaiting transfer to the initiator. The meaning of *target_data_pending* is unspecified for an unsolicited status block.

The *special* bit (abbreviated as *s* in the figure above) provides additional information pertinent to application data transferred from the target to the initiator. The meaning of the *special* bit is unspecified when the value of the *src* field is two, when (in the ORB identified by *ORB_offset_hi* and *ORB_offset_lo*) any of the *data_size* or *queue* fields or the *direction* bit are zero or if no data has been transferred. The meaning and usage of the *special* bit are application-dependent and shall apply to all of the application data contained within the buffer described by the ORB.

The *end_of_message* bit (abbreviated as *m* in the figure above) shall indicate whether or not a boundary exists in the application data or control information transferred from the target to the initiator. The meaning of the *end_of_message* bit is unspecified when the value of the *src* field is two or when the *direction* bit (in the ORB identified by *ORB_offset_hi* and *ORB_offset_lo*) is zero. Otherwise, when *end_of_message* is one, a boundary exists after the last byte of application data or control information described by the ORB. In the case of application data, the nature of the boundary and its interpretation shall be specified by the service definition. When the *control* bit (in the ORB identified by *ORB_offset_hi* and *ORB_offset_lo*) is

one, the *end_of_message* bit in the associated status block shall also be one; all control information for a single request or response shall be contained within one buffer.

When status is zero, the *residual* field shall specify the difference between the requested and actual data transfer lengths, in bytes. The meaning of residual field is unspecified for an unsolicited status block.

When *residual* is negative, no data has been transferred because of a mismatch between the size of the buffer and the data transfer length acceptable to the target: either the target's buffer space is too small to accept the data described by the ORB to which the completion status pertains or else the buffer described by the pertinent ORB is too small to accept the data available from the target. In these cases, the meaning of *residual* depends upon the value of the *direction* bit of the ORB to which the completion status pertains. When *direction* is zero (the flow direction is from the initiator to the target), the target shall calculate *residual* by subtracting the size of the buffer provided by the initiator from the maximum acceptable data transfer length. Otherwise, when *direction* is one (the flow direction is from the target to the initiator), the target shall calculate *residual* by subtracting the minimum acceptable data transfer length from the size of the buffer provided by the initiator. Negative values shall be encoded in two's complement notation.

Otherwise, when *residual* is greater than or equal to zero, there is no mismatch between the size of the buffer and the data transfer length to prevent data transfer. The target shall calculate *residual* by subtracting the actual data transfer length from the size of the buffer provided by the initiator. A *residual* value greater than zero is not necessarily indicative of an error.

5.3 Control information

Control information, both requests and their corresponding responses, may be exchanged between initiator and target *via* transport flow ORBs whose *queue* field is zero (control ORBs). This indicates that the data in the buffer (or the data to be stored in the buffer) associated with the ORB is control information rather than application data. Only one control request or response shall be transferred by an ORB; when the *direction* bit is zero the *end_of_message* bit in the ORB shall be one, otherwise the *end_of_message* bit in the status block shall be one. If the initiator has provided more control information than the target can accept or if the buffer is too small to receive all the target's control information, no transfer shall take place and the *residual* field shall indicate the appropriate transfer size (see 7.1 and 7.2). The format of the control information in the buffer is illustrated by Figure 12.

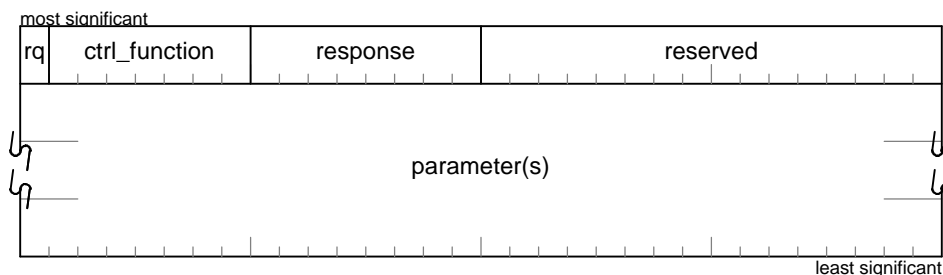

Figure 12 – Control information format

The *rq* bit shall specify whether the control function is a request or a response. A value of one indicates a request.

The *ctrl_function* field shall specify the control function, as defined by the table below.

<i>ctrl_function</i>	Name	Comment
0		Reserved for future standardization
1	CONNECT	Establish a connection with a particular service
2	SHUTDOWN QUEUE	Initiate the release of resources for a queue that will no longer be used
3	RELEASE QUEUE	Confirm that resources have been released when a queue is shutdown
4	SERVICE DIRECTORY	Query all the services implemented (identified by a list of service Ids)
5	STATUS	Query the availability of target data for all queues implemented by the target
6 – 7F ₁₆		Reserved for future standardization

The *response* field is valid only when the *rq* bit is zero. In this case, it encodes a response indication for the corresponding control function, as defined by the table below.

<i>response</i>	Definition
0	Request completed OK; response parameters are meaningful.
1	Unknown control function.
2	Insufficient resources are available to complete the request; the same request may succeed if resubmitted later.
3	The service identified by the SERVICE_ID parameter does not exist.
4	Mismatch between the actual and expected queue number parameter(s) provided in a CONNECT request and those expected by the service .
5	The connection request is refused.
6	The connection identified by the queue number parameter(s) does not exist.
FF ₁₆	Unspecified error.

The remainder of the control information, ~~up to the maximum size specified by data_size in the ORB that references the control information buffer~~, shall consist of zero or more parameters identified by a parameter ID (see Table 1). Relative to the start of the buffer, each parameter shall be quadlet-aligned and occupy an integral number of quadlets. The first parameter shall start in the second quadlet of control information and subsequent parameters, if any, shall immediately follow the preceding parameter. The order in which parameters appear is unimportant. [Either the parameters shall completely fill the control information or they shall be followed by a zero quadlet. The direction of data transfer determines the length of the control information. When the direction bit in the control ORB is zero, data_size shall specify the amount of control information otherwise its length shall be derived from data_size and residual. Any quadlets that follow the last parameter, up to the end of the control information, shall be cleared to zero.](#)

Table 1 – Parameter ID values

Parameter ID	Parameter Name	Value restrictions	Description
0		0	Indicates end of parameter list in control information (optional).
1	TASK_SLOTS	Minimum 1	For a particular connection, the maximum number of ORBs permitted in the task set. The initiator shall observe the limit established by the target and may optionally provide this parameter to indicate a self-imposed limit. Task slots are allocated <i>per</i> connection and may be used for any of the connection's queues.
2	I2T_QUEUE	Nonzero; FF ₁₆ maximum	The queue number assigned to the connection for the transport of application data from the initiator to the target
3	T2I_QUEUE		The queue number assigned to the connection for the transport of application data from the target to the initiator
4	MODE		Specifies the desired mode, datagram or stream, at the time a connection to a service is established.
80₁₆	SERVICE_ID	40 bytes maximum	An ASCII text string (without leading or trailing blank characters) that uniquely identifies a service.
81₁₆	QUEUE_INFO		A bit map that reports the state of <i>target_data_pending</i> for all queues implemented by the target (see Figure 15).

The parameter ID shall specify the parameter format, either immediate or variable-length. The most significant bit of the parameter ID determines the format; parameters whose ID values are in the range zero to 7F₁₆, inclusive, shall conform to the format specified by Figure 13 while those in the range 80₁₆ – FF₁₆, inclusive, shall conform to the format specified by Figure 14. All parameter ID values not specified are reserved for future standardization.

The format of immediate parameters is shown below.

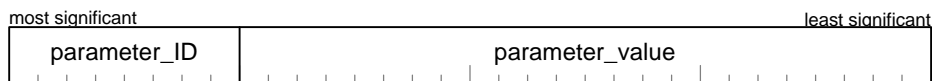

Figure 13 – Immediate parameter format

The *parameter_ID* field shall specify the parameter, as encoded by Table 1.

The *parameter_value* field shall specify the immediate value of the parameter. Unless otherwise specified for a particular value of *parameter_ID*, the *value* field shall contain an unsigned 24-bit number.

The format of variable-length parameters (which are usually ASCII text strings) is shown below.

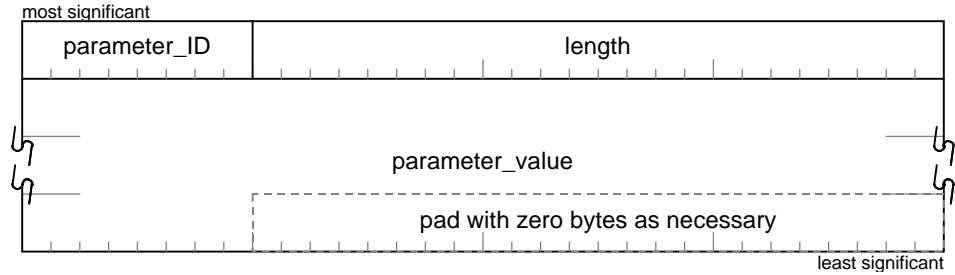

Figure 14 – Variable-length parameter format

The *parameter_ID* field shall specify the parameter, as encoded by Table 1.

The *length* field shall specify the length of the *parameter_value* field, in bytes. Pad bytes, if present, are excluded from the value of *length*.

The *parameter_value* field shall contain the value of the parameter and shall commence with the most significant byte of the parameter value. If the length of the parameter is not a multiple of four, the parameter value shall be padded with trailing bytes of zero.

5.4 Queue information

Queue information is an array; each entry reports status information for the queues implemented by the target. The length of the array is implementation-dependent (determined by the largest queue number supported by the target) and shall conform to the format illustrated by Figure 15.

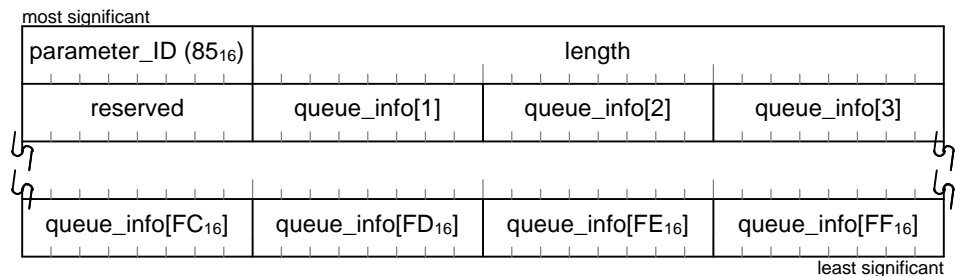

Figure 15 – Queue information format

The value of *parameter_ID* shall be 85₁₆.

The value of *length* shall be greater than the largest queue number implemented by the target and less than or equal to 256.

Each *queue_info* entry provides information for an individual queue; this array of bytes is directly indexed by the queue number. The first entry in the array is reserved.² For all other queues, the format of the *queue_info* byte is specified by Figure 16.

² Queue zero is always active; the availability of control information is indicated by the status block *attention* bit.



Figure 16 – Queue information byte format

The *active* bit shall be zero if the queue is not implemented by the target or not assigned to an established connection. A value of one indicates that the queue is in use by a connection.

The *target_data_pending* bit (abbreviated as *t* in the figure above) indicates the availability of target application data for the queue. When the *target_data_pending* bit is one, the initiator should post a transport flow ORB for the specified queue to retrieve the application data. The target shall zero this bit when there is no pending application data awaiting transfer to the initiator.

5.5 [Reverse login request and response](#)

[The reverse login facility utilizes a 64-byte block write addressed to an initiator's MESSAGE_REQUEST register or a target's MESSAGE_RESPONSE register. The format of the data payload conforms to draft standard IEEE P1212 and is illustrated by Figure 17.](#)

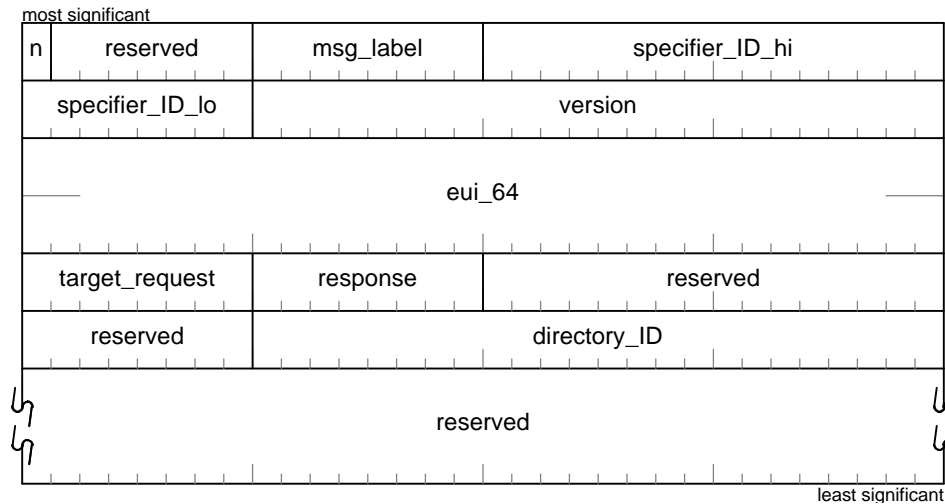

Figure 17 – Reverse login request / response format

[In a reverse login request addressed to an initiator's MESSAGE_REQUEST register, the *notify* bit \(abbreviated as *n* above\) shall be one; the initiator is requested to write a response to the target's MESSAGE_RESPONSE register. In the response returned to the target, *notify* shall be one if the initiator does not implement the reverse login facility; otherwise it shall be zero and *response* shall indicate the completion status of the request.](#)

[The *msg_label* field shall be zero.](#)

[The *specifier_ID* field shall be 00 5029₁₆.](#)

[The *version* field shall be zero.](#)

[The *eui_64* field shall be equal to the EUI-64 in the target's bus information block. The initiator shall leave this field unchanged when a response is written to the MESSAGE_RESPONSE register.](#)

The *target_request* field shall contain a value specified by the table below; all values not explicitly defined are reserved for future standardization.

<u>target_request</u>	<u>Name</u>	<u>Comment</u>
<u>0</u>	<u>NOP</u>	<u>No effects at initiator; response indicates whether or not initiator supports reverse login.</u>
<u>1</u>	<u>REVERSE LOGIN</u>	<u>Requests the initiator to login in to the specified node and unit directory.</u>

The *response* field shall be zero in a reverse login request addressed to an initiator. In the response returned to the target's MESSAGE RESPONSE register, *response* shall indicate completion status as specified by the following table.

<u>target_request</u>	<u>Name</u>	<u>Comment</u>
<u>0</u>	<u>OK</u>	<u>The request is acknowledged and the initiator will attempt the requested action.</u>
<u>1</u>	<u>RESOURCES UNAVAILABLE</u>	<u>The initiator cannot attempt a login at present; a subsequent REVERSE LOGIN request by the target may succeed.</u>
<u>FF₁₆</u>	<u>REJECTED</u>	<u>The request is rejected for unspecified reasons.</u>

The *directory_ID* field shall identify the unit to which the initiator is requested to transmit a LOGIN request. A directory's ID may be specified explicitly by a Directory ID entry or, absent such an entry, implicitly by the least significant 24 bits of the base address of the directory within node space.

6 Control operations

Before application client(s) and service(s) may exchange data in uni- or bi-directional transport flows (explained in detail in section 7), control operations are necessary to set up the communication paths. This section specifies the methods used by both initiator and target to establish and manage connections for these transport flows.

6.1 Login, [reverse login](#) and queue zero

Access to a target compliant with this standard commences with an SBP-2 login request by the initiator. Upon successful completion of the login request, the target has reserved resources for use by the initiator:

- SBP-2 registers assigned by the target at the time of the login (the AGENT_STATE, AGENT_RESET, ORB_POINTER, DOORBELL and UNSOLICITED_STATUS_ENABLE registers);
- queue zero, the control operations queue; and
- two task slots for use by queue zero ORBs.

[In cases where a target wishes to communicate with an initiator but no login exists, a target may use the "reverse login" facility to request an SBP-2 login from the initiator. The target constructs a reverse login message \(see 5.5\) and stores it at the initiator's MESSAGE_REQUEST register. If the target receives a success response at its own MESSAGE_RESPONSE register, the initiator either has attempted or shall attempt to establish a login. An initiator that initiates SBP-2 login in response to a reverse login request should persist in its attempts until a login response is received from the target.](#)

[NOTE – A target should not create a flood of reverse login requests; if no response is received to a reverse login request, the target should wait a reasonable, implementation-dependent time before retransmission of a the request.](#)

Once queue zero exists, either initiator or target may use it in a peer-to-peer fashion to communicate control information, requests or responses, to the other. At no time shall the task set contain more than two control ORBs.

The completion of a request requires two ORBs, one which describes the control information buffer that contains the request and a complementary ORB which describes the control information buffer for the response. Although queue zero provides full peer-to-peer functionality between initiator and target, the details of its use are asymmetric and vary according to whether the initiator or the target is the requester.

When an initiator issues a request to a target, they shall perform the following operations:

- a) The initiator shall store the request and its associated parameters (if any) in a buffer in system memory and signal to the target fetch agent an ORB, whose *queue* field and *direction* bit are zero and *end_of_message* bit is one, that describes the control information buffer;
- b) The target shall fetch the ORB and read the control information buffer. The status block stored by the target to complete the ORB may have its *attention* bit set to one to indicate that the target intends to transfer control information (the response) to the initiator;
- c) At any time the initiator receives a status block whose *attention* bit is one and there is no ORB in the task set whose *queue* field is zero and *direction* bit is one, the initiator shall create such an ORB and place it in the task set; and
- d) Once the target has executed the indicated request and there is an ORB in the working set whose *queue* field is zero and *direction* bit is one, the target shall store the response data in the buffer described by the ORB and then store completion status for the ORB. So long as the target has

pending control information to transfer to the initiator, it shall continue to set the *attention* bit to one in any status block (including unsolicited status) stored into the initiator *status_FIFO*.

NOTE – In order to reduce ORB fetch latency, the initiator may place two control information ORBs in the task set at the same time, the first for the request (with a *direction* bit of zero) and the second for the response (with a *direction* bit of one). Although the algorithm described above works correctly even if the initiator awaits a status block whose *attention* bit is one before signaling a target response ORB to receive the response data, it is more efficient to post both ORBs at the same time.

When a target issues a request to an initiator, they shall perform the following operations:

- a) The target shall set the *attention* bit to one in a status block stored into the initiator *status_FIFO*. Either unsolicited status or completion status associated with an ORB may be used. So long as the target has pending control information to transfer to the initiator, it shall continue to set the *attention* bit to one in any status block stored into the initiator *status_FIFO*.
- b) At any time the initiator receives a status block whose *attention* bit is one and there is no ORB in the task set whose *queue* field is zero and *direction* bit is one, the initiator shall create such an ORB and place it in the task set;
- c) Once there is an ORB in the working set whose *queue* field is zero and *direction* bit is one, the target shall store the control information data (request) in the buffer described by the ORB and then store completion status for the ORB. The *attention* bit shall be zero in the status block associated with the ORB;
- d) When the initiator has executed the indicated request, it shall store the response and its associated parameters (if any) in a buffer in system memory and signal to the target fetch agent an ORB that describes the control information buffer. The ORB's *queue* field and *direction* bit shall be zero and the *end_of_message* bit shall be one;
- e) The target shall fetch the ORB and read the response from the control information buffer. The status block stored by the target to complete the ORB may have its *attention* bit set to one if the target intends to transfer other control information (request or autonomous response) to the initiator.

It is possible for both initiator and target to initiate requests at roughly the same time. In this case the working set contains an ORB for transfer of the request from initiator to target while the status block *attention* condition is simultaneously asserted by the target. The ordered execution properties of queue zero give a natural precedence to initiator requests over target requests, as follows. When a target fetches an ORB whose *queue* field and *direction* bit are zero and whose *end_of_message* bit is one, the request contained in the control information shall be processed before a request is transferred to the initiator. Consequently, if a target has an uncompleted initiator request when it fetches a control ORB and whose *direction* bit is one it shall not store any control information except the response that completes the request.

When neither initiator nor target have outstanding requests or responses, the control queue (queue zero) is idle and there shall be no ORBs in the task set whose *queue* field is zero.

6.2 Autonomous response information

The preceding clause describes the use of queue zero for request / response pairs between initiator and target. It is also possible for either initiator or target to autonomously transfer response information to the other. Autonomous response information is typically status information and does not necessarily require any additional action on the part of the recipient.

Autonomous response information may be sent for any of the *ctrl_function* values enumerated in the table below.

<i>ctrl_function</i>	Name
4	SERVICE DIRECTORY
5	STATUS

The *response* code in autonomous response information shall be zero.

Autonomous response information shall not be transferred while there is an uncompleted control request. A target requests the transfer of autonomous response information by means of the status block *attention* bit. If a target asserts *attention* and subsequently fetches an initiator request ORB, it shall first complete the initiator's control request and transfer the corresponding response information to the initiator before transferring the autonomous response information. The *attention* bit shall remain asserted in any status blocked stored in the initiator *status_FIFO* while the transfer of the autonomous response information is pending.

6.3 Service discovery

Services implemented by either initiator or target are uniquely identified by their service ID, an ASCII string which may be registered with **TBD**. A client application that wishes to establish a connection with a particular service may attempt the connection without *a priori* knowledge that the service is implemented or the client application may request service directory information.

NOTE – Vendor-dependent services should be identified by a service ID string unlikely to be used by another vendor. One method is to include the vendor's name in the string.

A service discovery request shall have a *ctrl_function* code of SERVICE DIRECTORY and no parameters. The response information shall contain zero or more SERVICE_ID parameters that identify services implemented by the [initiator or](#) target. There is no requirement that all implemented services be listed in the service directory. The order of the SERVICE_ID parameters in the response is unspecified.

The service directory information available from a target may not fit within the buffer provided by the initiator. In this case, the target shall not store any response information but shall complete the queue zero ORB with a *status* of zero and a *residual* value that indicates the size of the available response information. The target shall discard the response information and, unless there is other pending control information awaiting transfer to the initiator, shall clear the *attention* bit in the status block. The initiator may reissue the service discovery request if it can provide a buffer large enough to accommodate the service ID response information.

[When the service directory information available from an initiator does not fit within a target's available memory, the target shall not fetch any response information but shall complete the queue zero ORB with a status of zero and a residual value that indicates the amount of response data the target is able to accept. The target may elect to retrieve the service directory information by the method described below.](#)

An alternative to the service discovery request is to establish a connection to a well-known service ID, "PPDT SERVICES". ~~Target~~ Support for this service is optional, but if implemented consists of a unidirectional queue to transfer service ID information to the ~~initiator~~ [requester](#) in stream mode. An initiator may receive service ID information by signaling transport flow ORBs whose *direction* bit is one and whose *queue* field specifies the queue identified in the connection response. When all available service ID information has been transferred to the initiator, the target shall set the *end_of_message* bit to one in the status block for the transport flow ORB that completed the transfer. [An initiator that provides service ID information to a target shall signal transport flow ORBs whose direction bit is zero and whose queue field specifies the queue identified in the target's connection request. When all available service ID information has been made available to the target, the initiator shall set the end_of_message bit to one in the last transport flow ORB. Once all service ID information has been transferred,](#) either the initiator or the target may initiate queue shutdown.

The service ID information shall consist of quadlet-aligned SERVICE_ID parameters in the format specified by Figure 14. There is no requirement that all implemented services be described by the parameters and their order is unspecified.

6.4 Connection management

Control ORBs are used to establish and terminate connections that permit the flow of application data between clients and services in either initiators or targets. The control requests are CONNECT, SHUTDOWN QUEUE and RELEASE QUEUE. The connection type is established when the connection is created and is implicitly encoded by the I2T_QUEUE and T2I_QUEUE parameters present in the connection request or response information, as specified by Table 2.

Table 2 – Connection type encoded by queue ID parameters

Connection type	I2T_QUEUE value	T2I_QUEUE value
Unidirectional	unrestricted	—
	—	unrestricted
Bi-directional (nonblocking)	not equal to T2I_QUEUE	not equal to I2T_QUEUE
Bi-directional (blocking)	equal to T2I_QUEUE	equal to I2T_QUEUE

Unidirectional connections are described by a single parameter, I2T_QUEUE or T2I_QUEUE. If both parameters are present, the connection is bi-directional and is either blocking or nonblocking according to whether the two parameter values are equal or different, respectively.

6.4.1 Connection establishment

Before a client application may communicate with a service, necessary resources shall be allocated and confirmed by means of a control request with a *ctrl_function* code of CONNECT and its corresponding response. The operations are fundamentally similar whether the service resides at the initiator or the target, but because the initiator and target control different resources, the procedures are described separately.

The only initiator resource required for a connection is sufficient system memory to hold the ORBs for that portion of the task set allocated to the connection.

The target resources required for a connection are one or two available queue numbers as well as local memory to hold active ORBs and their associated context (up to the maximum set by the target *via* the TASK_SLOTS parameter) ~~and an application client to provide the requested service.~~

Once a successful response has been received for a connection request, the initiator may place ORBs into the task set that use the queue number(s) specified in the target response data. The queue number(s) remain valid until either a LOGOUT (either explicit on the part of the initiator or implicit as the result of a failure to reconnect after a bus reset), a shutdown of either or both queues ~~or the connection is aborted.~~

6.4.1.1 Connection established by an initiator

When an application client at an initiator desires to establish a connection with a target service, it shall create a control ORB whose buffer contains a CONNECT control request. The initiator shall specify the SERVICE_ID and MODE parameters. The initiator may specify the TASK_SLOTS parameter, in which

case the initiator shall guarantee that the task set never contains more active ORBs for the connection than the value set by TASK_SLOTS.

If the connection is established, the target shall return response data that specifies TASK_SLOTS and one or both of the I2T_QUEUE and the T2I_QUEUE parameters. When the initiator has provided the optional TASK_SLOTS parameter in its request, the target should return a TASK_SLOTS value less than or equal to that specified by the initiator.

Connection requests may fail because of a lack of target resources. This failure mode is probably transient; if the CONNECT control request is retried at some unspecified future time it may succeed. Other failure modes, indicated by the *resp* code, are fatal and should not be retried.

6.4.1.2 Connection established by a target

An application client at a target that desires to establish a connection with an initiator service shall create a buffer that contains a CONNECT control request and signal the initiator to retrieve the control request by asserting the *attention* bit in a status block. The CONNECT control request shall specify the SERVICE_ID, MODE, TASK_SLOTS and one or both of the I2T_QUEUE and T2I_QUEUE parameters. If the connection is established, the initiator shall guarantee that the task set never contains more active ORBs for the connection than the TASK_SLOTS value provided by the target.

If the requested service exists at the initiator and supports the requested transport flow mode, datagram or stream, the connection may be confirmed by a control response from the initiator. No parameters are required in the control response, but if the initiator specifies the TASK_SLOTS parameter it shall guarantee that the task set never contains more active ORBs for the connection than the value provided.

The initiator shall not use the queue number(s) identified by the I2T_QUEUE or T2I_QUEUE parameters until successful completion status has been stored at the initiator's *status_FIFO* for the ORB that transferred the control response to the target.

Just as a target may refuse a connect request because of insufficient resources, so may an initiator. Such a failure is probably transient and may be retried at some unspecified future time.

6.4.2 Queue shutdown

Although connections, which consist of one or two queues, are established by a single control function, there is no corresponding unified function to request disconnection. Instead, each queue may be shutdown individually. When all queues allocated to a connection are shutdown, the connection no longer exists and all resources allocated to it may be released.

Either the client application or the service may request queue shutdown; there are no fundamental differences. A more important consideration is whether it is the queue's data producer or data consumer that initiates the shutdown. Queue shutdown requested by the producer may be orderly while shutdown requested by the consumer is unlikely to be orderly, as summarized by the table below.

Data transport flow	Queue shutdown requestor	
	Initiator	Target
Initiator to target (I2T_QUEUE)	Orderly	Abortive
Target to initiator (T2I_QUEUE)	Abortive	Orderly
Bi-directional (I2T_QUEUE equals T2I_QUEUE)	Application-dependent	

An orderly shutdown occurs when the consumer is able to successfully receive all the data produced prior to queue shutdown. An abortive shutdown is characterized by the loss of data between the two endpoints. Whether or not the shutdown of a bi-directional queue is abortive or orderly is dependent upon usage rules agreed by the client application and service and is beyond the scope of this document.

6.4.2.1 Queue shutdown by an initiator

When an application client or service at an initiator desires to shutdown a queue, it shall signal a transport flow ORB to the target whose *final* and *notify* bits are one and whose *queue* field specifies the queue to be shutdown. The initiator shall not signal any other ORBs with the same *queue* value unless the target allocates the queue number upon future establishment of a connection. A data buffer may be associated with a transport flow ORB whose *final* bit is one.

If the direction of data transfer *via* the queue is from target to initiator, the initiator shall signal a control ORB whose buffer contains a SHUTDOWN QUEUE control request whose T2I_QUEUE parameter is equal to the value of the *queue* field in the final ORB. This avoids a deadlock with the target and insures that the final ORB is eventually fetched and processed by the target.

NOTE – If the direction of data transfer *via* the queue is from initiator to target, the initiator may signal a control ORB whose buffer contains a SHUTDOWN QUEUE control request whose I2T_QUEUE parameter is equal to the value of the *queue* field in the final ORB. This may be necessary if the target is unresponsive and not processing ORBs for the queue.

A target that receives a SHUTDOWN QUEUE request shall commence execution of all active ORBs for the queue identified by the I2T_QUEUE or T2I_QUEUE parameter. If the direction of data transfer is from the initiator to the target, the target shall not defer completion of any ORB for the queue solely because the receiving client application or service has not provided sufficient buffer space but shall complete the ORB without transferring all available data. Otherwise, if the direction of data transfer is from the target to the initiator, the target shall not defer completion of any ORB for the queue solely because the client application or service has not provided sufficient data. Regardless of the direction of data transfer, the *residual* field in the status block for the ORB shall report the actual data transfer.

Once the target completes any indicated data transfer for the final ORB, it shall mark the queue as provisionally shutdown and store completion status at the initiator's *status_FIFO*. The target may not yet release the resources associated with the queue. If the initiator signals any other ORBs whose *queue* field identifies the provisionally shutdown queue, the target shall reject these with a *status* of ~~six~~ [one](#) (invalid queue).

After the target has completed the final ORB, it shall discard any data generated by a client application or service for the provisionally shutdown queue. Because a service or client application at the initiator is unaware of the discarded data, if any, the shutdown of a queue used for data transfer from the target to the initiator may be disorderly (abortive) when requested by the initiator.

When the initiator receives completion status for the final ORB, it shall signal a control ORB whose buffer contains a RELEASE QUEUE control request. For a unidirectional queue, the initiator shall specify the I2T_QUEUE or T2I_QUEUE parameter, as appropriate, to identify the queue to be released. For a bi-directional queue, the initiator shall specify both parameters and their values shall be equal. If completion status for the control ORB indicates that the RELEASE QUEUE control request was not delivered to the target, the initiator shall either signal the control ORB again or reset the target by a write to its RESET_START register. Once completion status indicates successful receipt of the RELEASE QUEUE control request by the target, no additional initiator action is necessary. The RELEASE QUEUE control request has no corresponding response.

A target that receives a RELEASE QUEUE control request whose I2T_QUEUE or T2I_QUEUE parameter identifies a queue marked provisionally shutdown should release all resources allocated to the queue. Otherwise the target shall ignore the request. If no active queues remain for the connection to which the queue was originally allocated, any additional connection resources should be released. The target shall not respond to a RELEASE QUEUE control request.

6.4.2.2 Queue shutdown by a target

When an application client or service at a target desires to shutdown a queue, it shall create a control ORB whose buffer contains a SHUTDOWN QUEUE control request and signal the initiator to retrieve the control request by asserting the *attention* bit in a status block. For a unidirectional queue, the target shall specify the I2T_QUEUE or T2I_QUEUE parameter, as appropriate, to identify the queue to be shutdown. For a bi-directional queue, the target shall specify both parameters and their values shall be equal. Once completion status indicates successful receipt of the SHUTDOWN QUEUE request by the initiator, the target shall not defer completion of any ORB for the queue. When the direction of data transfer is from the initiator to the target, transport flow ORBs shall be completed without data transfer. Otherwise, when the direction of data transfer is from the target to the initiator, the completion of transport flow ORBs shall not be delayed solely because insufficient data is available. In both cases, the *residual* field in the status blocks stored for the transport flow ORBs shall report the actual data transfer.

NOTE – If the direction of data transfer *via* the queue is from target to initiator and an orderly shutdown is intended, the target's client application or service should cease generation of data and the target should complete all outstanding data transfers before issuing the SHUTDOWN QUEUE request.

An initiator that receives a SHUTDOWN QUEUE request shall signal a transport flow ORB to the target whose *final* and *notify* bits are one and whose *queue* field specifies the queue identified in the control parameters for the request. The initiator shall not signal any other ORBs with the same *queue* value unless the target allocates the queue number upon future establishment of a connection. A data buffer may be associated with a transport flow ORB whose *final* bit is one.

Once the target completes any indicated data transfer for the final ORB, it shall mark the queue as provisionally shutdown and store completion status at the initiator's *status_FIFO*. The target may not yet release the resources associated with the queue. If the initiator signals any other ORBs whose *queue* field identifies the provisionally shutdown queue, the target shall reject this with a *status* of ~~six~~ one (invalid queue).

After the target has completed the final ORB, it shall discard any data generated by a client application or service for the provisionally shutdown queue. Because a service or client application at the initiator is unaware of the discarded data, if any, the shutdown of a queue used for data transfer from the target to the initiator may be disorderly (abortive) when requested by the initiator.

When the initiator receives completion status for the final ORB, it shall signal a control ORB whose buffer contains a RELEASE QUEUE control request. For a unidirectional queue, the initiator shall specify the I2T_QUEUE or T2I_QUEUE parameter, as appropriate, to identify the queue to be released. For a bi-directional queue, the initiator shall specify both parameters and their values shall be equal. If completion status for the control ORB indicates that the RELEASE QUEUE control request was not delivered to the

target, the initiator shall either signal the control ORB again or reset the target by a write to its RESET_START register. Once completion status indicates successful receipt of the RELEASE QUEUE control request by the target, no additional initiator action is necessary. The RELEASE QUEUE control request has no corresponding response.

A target that receives a RELEASE QUEUE control request whose I2T_QUEUE or T2I_QUEUE parameter identifies a queue marked provisionally shutdown should release all resources allocated to the queue. Otherwise the target shall ignore the request. If no active queues remain for the connection to which the queue was originally allocated, any additional connection resources should be released. The target shall not respond to a RELEASE QUEUE control request.

6.4.2.3 Simultaneous queue shutdown by initiator and target

Unaware of the other's actions, an initiator and a target might initiate shutdown of the same queue simultaneously. In this case, there is no guarantee of orderly shutdown.

If an initiator receives a SHUTDOWN QUEUE control request that identifies a queue for which a final ORB has already been signaled it shall take no action.

No action is required of a target when a initiator signals a final ORB at roughly the same time as the target issued a SHUTDOWN QUEUE request. The unordered, split transaction properties of Serial Bus make it impossible for the target to distinguish this situation from a delay in the receipt of the SHUTDOWN QUEUE request.

6.5 Queue status information

A target may transfer autonomous queue status information to an initiator when target data is available for a queue (*i.e.*, *target_data_pending* would be set to one in the status blocks stored for any transport flow ORBs for the queue) but the initiator has not signaled any ORBs for the queue. In this circumstance, the target is not able to indicate the presence of data except by an indirect route.

The target may indicate the pending control information by setting the *attention* bit to one in any status block stored at the initiator's *status_FIFO*. The initiator should post a control ORB whose *direction* bit is one in order to retrieve the control information from the target. When such an ORB is signaled, the target may transfer [autonomous](#) response information [for the STATUS control function](#) that contains a QUEUE_INFO parameter. The queue information notifies the initiator which queues have target data available.

If there are no ORBs in the target's task set, the target may communicate the *attention* bit to the initiator by means of an unsolicited status block. Once the initiator is aware of a target attention condition, it should post a control ORB whose *direction* bit is one.

7 Transport flow operations

Once a connection is established between a client application and a service, work is accomplished by the uni- or bi-directional flow of application-dependent data between the two. This section describes transport flow (and error recovery procedures) from the viewpoint of a queue instead of that of a connection; the reader may generalize from a single queue's operation to two coordinated queues that form a nonblocking bi-directional connection.

Service implementers select a datagram or stream model of transport flow. The datagram model is the simplest: there is a one-to-one relationship between ORBs, buffers and service data units (SDUs), as illustrated by Figure 18. The end of an SDU is demarcated by the *end_of_message* bit, which is always one when the datagram model is used.

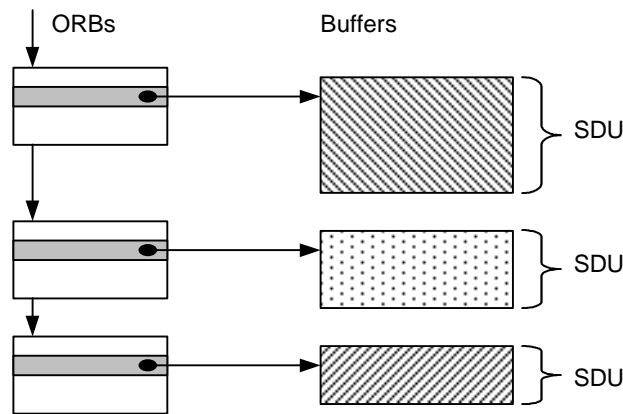

Figure 18 – Transport flow (datagram model)

The stream model permits SDU boundaries (e.g., the separation between pages or print jobs for a printer) to occur without regard for the boundaries between data buffers specified by different ORBs. Figure 19 illustrates the relationship between stream data, the ORBs that describe its buffers and the SDUs.

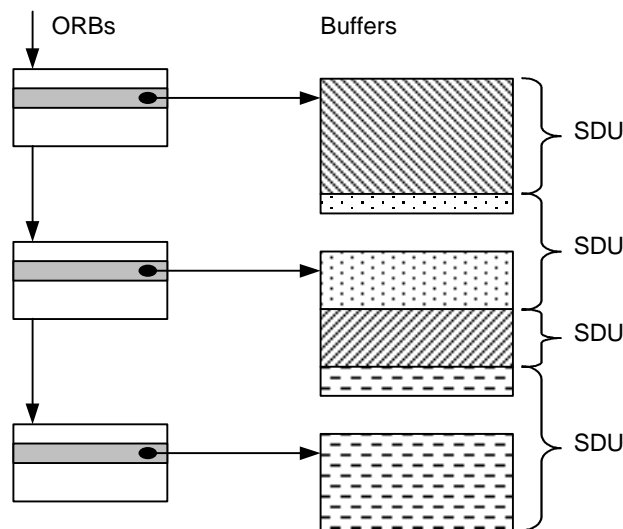

Figure 19 – Transport flow (stream model)

In the preceding figure, the stream data is assumed to be self-descriptive: it may be parsed by its recipient without the necessity for the ORBs to explicitly mark the SDU boundaries. The stream model may also be used in conjunction with SDUs that span more than one buffer, as illustrated by Figure 20.

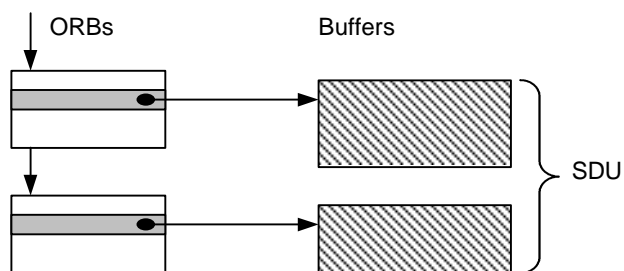

Figure 20 – Transport flow (spanned datagram model)

In the preceding figure, the *end_of_message* bit is zero in all but the last ORB. Spanned datagrams may be freely intermixed with the simple datagram model shown by Figure 18.

7.1 Data transfer to a target

Application data is transferred to a target by means of transport flow ORBs whose *direction* bit is zero. Within the limits of *TASK_SLOTS* allocated by the target at the time the connection (identified by the *queue* field) was established, the initiator may post more than one such outstanding transport flow ORB to the task set at a time. ORB fetch latency is reduced if the initiator is permitted to have at least two such outstanding ORBs in the task set.

The target transport may use read requests that address the data buffer in arbitrary order so long as none of the data is presented to an application client out of order. Upon successful completion of the data transfer, the *residual* field in the status block shall be zero.

The transport flow mode, datagram or stream, established when the connection was created, governs behavior when the initiator has more data available than the target is capable of processing at one time. For stream mode, this condition cannot arise; the target transfers data within the limits of local memory, delivers the data to the application client and continues to transfer data as local memory is released by the application client. Barring an unrecoverable error in the data transport or application client, all of the data described by the ORB is eventually transferred.

When datagrams are used, the possibility exists that an SDU is larger than the maximum acceptable to the target. In this case, no data shall be transferred and the *residual* field shall indicate the error condition. Figure 21 shows the relationship between the initiator's data buffer, the maximum SDU acceptable to the target and the value of *residual*. For simplicity, the figure assumes that no page table is used.

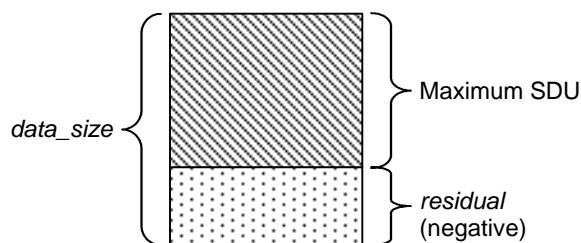

Figure 21 – Excess initiator data (datagram model)

The initiator may calculate the target's maximum acceptable SDU size by adding *residual* to *data_size*.

7.2 Data transfer to an initiator

Application data is transferred to an initiator by means of transport flow ORBs whose *direction* bit is one. Within the limits of *TASK_SLOTS* allocated by the target at the time the connection (identified by the *queue* field) was established, the initiator may post more than one such outstanding transport flow ORB to the task set at a time. ORB fetch latency is reduced if the initiator is permitted to have at least two such outstanding ORBs in the task set.

A target shall report the availability of data for a queue by setting *target_data_pending* bit to one in all status blocks stored for that queue's ORBs, regardless of the value of their *direction* bit, so long as there is untransferred data. If the initiator has posted no ORBs for a queue, the target may set *attention* to one in the status block for any ORB. This requests the initiator to post a control ORB to transfer queue information from the target (see 6.5) which in turn causes the initiator to post transport flow ORBs whose *direction* bit is one for the queues with available data.

The target transport may use write requests that address the data buffer in arbitrary order so long as successful completion status is not reported to the initiator until all of the data has been transferred. ~~Upon successful completion of the data transfer, the *residual* field in the status block shall be zero.~~

The transport flow mode, datagram or stream, established when the connection was created, governs behavior when the target has more data available than the initiator is capable of processing at one time. For stream mode, this condition cannot arise; the target transfers data (supplied by its application client) within the limits of the data buffer provided by the initiator; if more data is available from the application client, the *target_data_pending* bit shall be one and the target awaits a subsequent ORB for the same queue whose *direction* bit is one. Unless an unrecoverable error occurs in the data transport, the target continues to fill initiator buffers so long as data is available.

When datagrams are used, the possibility exists that an SDU available at the target is larger than data buffer provided by the initiator. In this case, no data shall be transferred and the *residual* field shall indicate the error condition. Figure 22 shows the relationship between the initiator's data buffer, the SDU available at the target and the value of *residual*. Although the figure assumes that no page table is used, the relationships remain valid if a page table is present—except that the buffer size is summed from the page table elements instead of being directly available as *data_size*.

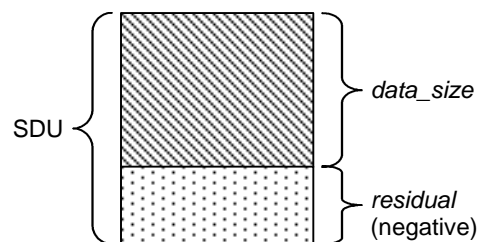

Figure 22 – Excess target data (datagram model)

The initiator may calculate the minimum buffer size necessary to receive the SDU by subtracting *residual* from *data_size*.

7.3 Completion status

The target shall signal completion status for a transport flow ORB by storing a status block to the initiator *status_FIFO* active for the login. Unless the buffer is sized incorrectly or a nonrecoverable error occurs, the target shall transfer all the data specified by the ORB and receive a response subaction of

resp_complete for each data transfer request subaction before it stores completion status to the initiator *status_FIFO*. All pending request subactions for the data transfer specified by the ORB shall be completed before the target stores a status block for the ORB to the initiator *status_FIFO*.

Although ANSI NCITS 325-1998 does not constrain targets which implement the unordered execution model to store completion status in order, this standard requires compliant targets to store completion status for each queue's ORBs in order as they are completed. In addition, the initiator shall deliver completion status to client applications or services in the same order indicated by the target. If a single event, such as an aborted task set, causes the initiator to simultaneously complete more than one ORB, the completion status shall be reported to the client in the same order as the ORBs were signaled to the target.

7.4 Execution context for active ORBs

This document specifies a data transport between services and their application clients that is reliable across interruptions, such as a bus reset, that cause target task set(s) to be aborted. The data transport is not only robust in these circumstances, but efficient. Data transfer may be quickly resumed without the necessity to redundantly move data already stored in or retrieved from an initiator's buffers. This is accomplished by cooperation between initiator and target in the use of the *signature* information field in transport flow ORBs. The *signature* field provides a method for the target to recognize an ORB previously active in an aborted task set.

In order to recognize and correctly resume execution for previously active ORBs, the target shall maintain context information (a history log) for each active ORB. An ORB is active from the time the target fetches it and commences data transfer³ up until the time completion status for the ORB is stored at the initiator's *status_FIFO* and either an *ack_pending* (with a subsequent response of *resp_complete*) or else an *ack_complete* are received by the target.

The exact details of context information maintained by a target are implementation-dependent, but the context shall be sufficient to correctly resume execution of a previously active ORB if signaled by the initiator after a task set abort. At a minimum, context information consists of the *direction*, *special* and *end_of_message* bits and the *queue* and *signature* fields for each active ORB as well as the status of data transfer—in progress or completed successfully or in error. Context information probably includes the original buffer size (derived from page table entries if a page table is associated with the ORB), the amount of data already transferred or remaining to be transferred and ~~a pointer to~~ [the offset of](#) the current location within the data buffer.

Context information for an active ORB shall be discarded when the target receives a successful completion response after storing the status block for that ORB at the initiator's *status_FIFO* or when a successful completion response is received after storing a status block for a subsequent ORB for the same queue. An ORB is subsequent to another if it was signaled by the initiator after the first ORB.

7.5 Error recovery

All of the events in the following table cause one or more of the target's task sets to be aborted; see ANSI NCITS 325-1998 for details. Unless otherwise noted, a target shall preserve execution context for active ORBs across these events.

³ The exact point in time at which an ORB becomes active is implementation-dependent and consequently difficult to define. An ORB is not yet active if the same ORB, signaled by an initiator after a bus reset, does not require context information in order for the target behavior to be essentially the same as if no bus reset had occurred. Whether or not data has been transferred is often an unreliable measure of an ORB's active status. For example, if a printer is designed to accumulate some minimum quantity of data before commencing image transfer to the medium, and ORB might not be active until print engine started.

Event	AGENT_STATE.st	Comment
Unrecoverable transaction errors	DEAD	Store status block TRANSPORT FAILURE for faulted ORB, if possible.
ABORT TASK SET		
LOGICAL UNIT RESET		Target support for LOGICAL UNIT RESET is optional
Fetch agent reset (write to AGENT_RESET)	RESET	
TARGET RESET	DEAD	
Bus reset	RESET	For each login, a target shall retain, for at least <i>reconnect_hold</i> + 1 seconds after the bus reset, sufficient information to permit initiators to reconnect their logins. After this time, a target shall discard execution context for the task set of any initiator that failed to reconnect.
Command reset (write to RESET_START)		These events are equivalent; execution context for all ORBs in all task sets shall be discarded. Device operations should be halted and the device restored to an idle condition.
Power reset		

Unrecoverable transaction errors may be caused by a missing acknowledgement packet, a split transaction timeout, a data error or a retry limit exceeded. A missing acknowledgment by itself is not necessarily an unrecoverable error; the target shall wait a split timeout period before further action. If a transaction response is received within the split timeout period, there is no error. Otherwise, a split transaction timeout has occurred. In the case of a data error or a split transaction timeout, if the request was not addressed to an initiator *status_FIFO*, target may retry the transaction up to some implementation-dependent limit. Once the target deems a transaction error unrecoverable, it shall set the *resp* field in the status block stored for the faulted ORB to TRANSPORT FAILURE and transition the fetch agent to the dead state.

When an unrecoverable transaction errors occur for a request that does not address an initiator *status_FIFO*, the target should attempt to store completion status for the faulted ORB before transitioning the fetch agent to the dead state. This notifies the initiator that error recovery is necessary. If an unrecoverable transaction error occurs for a write request addressed to an initiator's *status_FIFO*, the target shall take no additional action. It is the initiator's responsibility to detect such an error, usually by means of a timeout.

After a task set has been aborted, an initiator's client applications and services may resume data transfer with the target's services and client applications on a queue by queue basis.

Data transfer between a client application and a service may have caused device operations to commence even if not all the data had been transferred before the task set was aborted. For this reason, it is essential for each queue to be resumed by one of two methods. The simplest is to abandon any operations in progress, flush initiator and target buffers as necessary and return both endpoints of the queue to a known state—at which point the abandoned operation(s) may be reinitiated. The other approach is more efficient and uses execution context for active ORBs to permit resumption of data transfer at the point at which it was interrupted.

NOTE – A prerequisite to the resumption of data transfer is the existence of a login (the initiator reconnects to the target if there was a bus reset) and a reset fetch agent (the initiator writes to AGENT_RESET if the target's fetch agent had been left in the dead state after the task set was aborted).

An initiator may implement simple recovery for a queue by signaling an ORB whose *signature* differs from those of all ORBs active at the time the task set was aborted.

Although this method is robust, it may be improved upon. If the client application and service can reliably resume data transfer from the point it was interrupted, it may be unnecessary to cancel operations and flush buffers. In order for this method to work, the transport must be able to recognize resumption of an ORB active at the time the task set was aborted. The *signature* field in a transport flow ORB (see 5.1) provides a method by which previously active ORBs may be recognized if they are resubmitted after a task set abort.

If the initiator elects not to reset the queue by signaling an ORB with a fresh *signature* value, data transfer may be safely resumed if initiator and target can identify, for each queue, the ORBs active at the time the task set was aborted. For a particular queue, an initiator considers an ORB to be active if no completion status has been received from the target while a target considers an ORB active until positive acknowledgment of the receipt of completion status is signaled by the initiator. When an initiator wishes to resume data transfer for a particular queue from the point at which it was interrupted, it shall perform the following steps:

- a) If there were no active ORBs in the task set for the queue to be resumed, no action is necessary and the initiator may resume data transfer for the queue;
- b) Otherwise, for each previously active ORB for the queue, the initiator shall signal an equivalent ORB to the target fetch agent. Certain parts of the ORB shall remain unchanged: the *direction*, *special* and *end_of_message* bits and the *queue* and *signature* fields shall have the same values both before and after the task set abort. The *data_descriptor*, and *data_size* fields and the *page_table_present* may have different values but they shall describe a buffer of the same size and whose contents are identical to the buffer described by the ORB at the time it was aborted. If a bus reset caused the task set to be aborted, the *spd* and *max_payload* bits may differ as a result of changed topology between the initiator and target. An initiator shall signal equivalent ORBs in the same relative order within a queue as they had been prior to the task set abort.
- c) Once all the previously active ORBs for a particular queue have been signaled, the initiator may signal new ORBs in any order; these shall be interpreted by the target as if they are new; there are no restrictions on their field values.

When the target fetches an ORB, the action taken depends upon the value of the *queue* and *signature* field, which together uniquely identify an execution context for the initiator. If the value of *signature* is equal to the signature of an ORB active for the queue at the time the task set was aborted, the target shall discard execution context information for any older, previously active ORBs for the same queue. An ORB is older than another ORB if it was signaled before the other ORB. If the value of the *signature* field is not equal to any previously active ORB for the queue, the target shall discard all execution context information for that queue.

When the *signature* field identifies execution context for a previously active ORB, the target operations are determined by the data transfer state at the time the task set was aborted. If the data transfer had completed, successfully or in error, and completion status had been written to the initiator's *status_FIFO* (but no response had been received from the initiator), the target simply stores the same completion status again. ~~The ORB remains active~~ The target shall maintain context information for the ORB until the conditions specified by 7.4 are met. Otherwise, when data transfer had been in progress, the target shall resume data transfer from the point specified by the execution context for the ORB.

8 Configuration ROM

All devices compliant with this standard shall implement general format configuration ROM in accordance with IEEE Std 1394-1995, draft standards IEEE P1394a and IEEE P1212 and the additional requirements of this document. Targets compliant with this standard shall also conform to the configuration ROM requirements of ANSI NCITS 325-1998, except as specifically exempted by this document. General format configuration ROM is a self-descriptive structure; an example appropriate to a target is illustrated below.

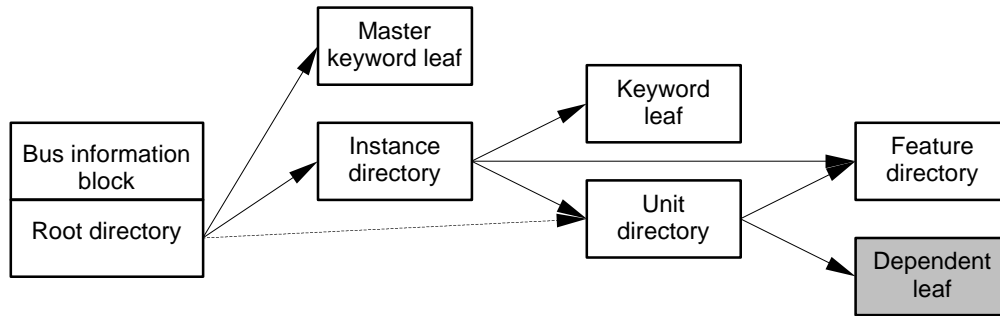

Figure 23 – Example configuration ROM hierarchy

With the exception of the dependent leaf (shown shaded), all of the configuration ROM components shown above are required for targets compliant with this standard. The connection from the root directory to the unit directory (shown by a dashed line) is optional; instance directories are the preferred access routes for unit directories.⁴

In addition to the requirements of the referenced standards and draft standards, the first five quadlets of configuration shall conform to the format illustrated by Figure 24.

most significant																
bus_info_length					crc_length					crc						
31 ₁₆ ("1")					33 ₁₆ ("3")					39 ₁₆ ("9")			34 ₁₆ ("4")			
m	c	i	b	p	reserved	cyc_clk_acc				max_rec	max_ROM	generation	r	link_spd		
node_vendor_ID											chip_ID_hi					
least significant																
chip_ID_lo																

Figure 24 – First five quadlets of configuration ROM

The *bus_info_length* field shall have a value of four.

The *crc_length* field shall have a value of four plus the size, in quadlets, of the root directory. This indicates that the *crc* field is calculated for both the bus information block and the root directory—but not for any of the other configuration ROM data structures. The value of the *crc* field shall be calculated in accordance with draft standard IEEE P1212.

⁴ ANSI NCITS 325-1998 mandates a Unit_Directory entry in the root directory; this document is noncompliant in that respect and adheres to the more contemporary recommendations of draft standard IEEE P1212.

The second quadlet shall contain the string "1394" in ASCII characters as specified by draft standard IEEE P1394a.

The meaning and usage of the *irmc*, *cmc*, *isc*, *bmc* and *pmc* bits (abbreviated as *m*, *c*, *i*, *b* and *p*, respectively, in the figure above) and the *cyc_clk_acc*, *max_rec*, *max_ROM*, *generation*, *link_spd*, *node_vendor_ID*, *chip_ID_hi* and *chip_ID_lo* fields are specified by draft standard IEEE P1394a.

The *max_rec* field shall have a minimum value of five.

The *max_ROM* field shall have a minimum value of one.

8.1 Root directory

Configuration ROM for devices compliant with this standard shall contain a root directory. The root directory immediately follows the bus information block and has an address of FFFF F000 0414₁₆. Relevant mandatory and optional entries for the root directory are summarized by the table below; unless explicitly excluded, any optional root directory entries permitted by draft standard IEEE P1212 are also permitted by this document.

Table 3 – Root directory entries

Directory entry		Mandatory	Description
Name	Type		
Vendor_ID	I	Y	24-bit RID of the vendor that manufactured the device. This entry shall be immediately followed by a Textual_Descriptor entry. The addressed textual descriptor leaf (or leaves, if an intermediate textual descriptor directory exists) should contain an informal form of the vendor name easily recognizable by users.
Node_Capabilities	I	Y	Identifies which options of the CSR architecture are implemented.
Node_Unique_ID	L		Although permitted by draft standard IEEE P1212, devices compliant with this standard shall not include a Node_Unique_ID entry in the root directory.
Keyword_Leaf	L	Y	"Thumbnail" description of the characteristics of the all instances implemented by the device.
Instance_Directory	D	Y	The instance directories provide a method to group unit architectures (software protocols) to identify shared physical components.
Unit_Directory	D		Unit_Directory entries are applicable only for targets. The use of Unit_Directory entries in the root directory is discouraged; designers should consult draft standard IEEE P1212 for more information.

The Vendor_ID entry shall contain the RID of the vendor that manufactured the device and shall be immediately followed by a Textual_Descriptor entry that specifies the location of either a textual descriptor directory or leaf. The referenced textual descriptor leaf or leaves should contain an informal (short) form of the company name of the vendor.

A Keyword_Leaf entry is optional within the root directory and, if present, shall specify the location of a keyword leaf in configuration ROM. The keywords included in the keyword leaf shall be the union of all keywords from all keyword leaves in the device's configuration ROM. Simple devices that implement only one instance may reuse its keyword leaf as the master keyword leaf.

At least one Instance_Directory entry is required in the root directory; each shall specify the location of an instance directory in configuration ROM.

8.2 Instance directories

Configuration ROM for devices compliant with this standard shall contain one or more instance directories, each of which describes the function(s) implemented by a particular instantiation within the device. The mandatory and optional directory entries for an instance directory are specified by draft standard IEEE P1212.

All instance directories shall contain a Keyword_Leaf entry.

8.3 Feature directories

All unit directories compliant with the requirements of clause 8.4 shall contain a Feature_Directory entry that specifies the location of a feature directory whose content and meaning are compliant with this clause. Configuration ROM may contain feature directories whose content and meaning are specified either by this standard, another organization or vendor. Relevant mandatory and optional entries for feature directories compliant with this document are summarized by the table below; unless explicitly excluded, any optional feature directory entries permitted by draft standard IEEE P1212 are also permitted by this document.

Table 4 – Feature directory entries

Directory entry		Mandatory	Description
Name	Type		
Specifier_ID	I	Y	24-bit RID of the directory specifier, 00 5029 ₁₆ .
Version	I	Y	In combination with the directory specifier ID, it identifies the software interface for the unit.
Service_ID	L		Collection of service ID text strings for all services implemented for the instance or unit.
Initiator_Capabilities	I		Indicates that the instance can function as an SBP-2 initiator.

The Specifier_ID entry, whose 24-bit immediate value shall be 00 5029₁₆, and the Version entry, whose 24-bit immediate value shall be zero, identify this document as the specification of the feature directory.

The Service_ID entry, if present, shall specify the location of a leaf in configuration ROM that contains text strings, each of which is the service ID of a service implemented by the instance or unit. The format of the leaf shall be identical to that specified by draft standard IEEE P1212 for keyword leaves.

8.4 Keyword leaves

Each instance directory shall be characterized by a set of appropriate keywords selected from Table 5 and placed in a keyword leaf referenced by a Keyword_Leaf entry in the instance directory. Additional

keywords may be present in any keyword leaf, but their meaning and usage are beyond the scope of this standard. Instances that share exactly the same set of keywords may reference the same keyword leaf.

Table 5 – Recommended keywords

Keyword	Recommended usage
CAMERA	Captures digital images.
COLOR	More than grayscale capabilities are supported, but the device may operate in a grayscale only mode.
DISK	Nonvolatile storage, often rotating.
FAX	Implements facsimile protocols commonly used over public switched telephone networks (PSTN) or integrated services digital networks (ISDN).
IMAGE	Applicable to devices that capture, manipulate or transduce images.
INITIATOR	Identifies the presence of initiator capabilities independently of target capabilities.
MULTIFUNCTION	Indicates the grouping of separate functions (e.g., fax, printer and scanner) into a single controllable entity. Superior control may be available if the device is used as an MFP instead of as its separate functions.
MODEM	Data transmission protocols; may be dedicated or public switched telephone networks (PSTN).
PHOTO	Suited to the processing of photographic images.
PRINTER	Output device that marks removable media (hardcopy).
SBP-2	Applicable to all devices described by this standard.
SCANNER	Captures digital images, usually by means of relative motion between a sensor and a document.

8.5 Unit directories

Configuration ROM for targets compliant with this standard shall contain one or more unit directories, each of which specifies a software interface (unit architecture) for a device function. Relevant mandatory and optional entries for unit directories are summarized by the table below; unless explicitly excluded, any optional unit directory entries permitted by draft standard IEEE P1212 or ANSI NCITS 325-1998 are also permitted by this document.

Table 6 – Unit directory entries

Directory entry		Mandatory	Description
Name	Type		
Specifier_ID	I	Y	24-bit RID of the directory specifier.
Version	I	Y	In combination with the directory specifier ID, it identifies the software interface for the unit.
Command_Set_Spec_ID	I	Y	24-bit RID of the command set specifier, 00 5029 ₁₆ .
Command_Set	I	Y	In combination with the command set specifier ID, it identifies the command set for the unit.
Management_Agent	I	Y	Provides the address of the SBP-2 MANAGEMENT_AGENT register for login to the device.
Unit_Characteristics	I	Y	
Logical_Unit_Number	I	Y	
Reconnect_Timeout	I		Describes the maximum reconnect timeout supported by a logical unit; a minimum value of ten seconds is recommended
Feature_Directory	D	Y	Additional information that describes features (usually independent of the software interface and command set) of the unit. At least one of the feature directories shall be specified by this standard.

The Specifier_ID entry, whose 24-bit immediate value shall be 00 609E₁₆, and the Version entry, whose 24-bit immediate value shall be 01 0483₁₆, identify the device as compliant with ANSI NCITS 325-1998, SBP-2.⁵

The Command_Set_Spec_ID entry, whose 24-bit immediate value shall be 00 5029₁₆, and the Command_Set entry, whose 24-bit immediate value shall be zero, identify the device as compliant with this document. The optional Command_Set_Revision entry, if present, shall have a 24-bit immediate value of zero.

The Unit_Characteristics entry shall specify a vendor-dependent *mgt_ORB_timeout* and an ORB size of eight quadlets (32 bytes). Consult ANSI NCITS 325-1998 for details.

Devices compliant with this standard shall contain a single Logical_Unit_Number entry for logical unit zero in each unit directory. The entry shall specify an unordered execution model (the *ordered* bit shall be zero). The *device_type* field shall be 1F₁₆, unspecified device type.

The Reconnect_Timeout entry is optional, but because connections between client(s) and service(s) are terminated by a reconnection failure, designers should give careful consideration to a value for *max_reconnect_hold*. Omission of this entry sets the default value to one second, which may not be appropriate for the intended application.

There shall be at least one Feature_Directory entry that specifies the location of a feature directory whose content and meaning are specified by this standard. There may be additional Feature_Directory entries

⁵ The names given are those used by draft standard IEEE P1212; they correspond to the names Unit_Spec_ID and Unit_SW_Version, respectively, in both ISO/IEC 13213:1994 and ANSI NCITS 325-1998.

that reference feature directories whose content and meaning are specified either by this standard, another organization or vendor.

8.6 Device ID

IEEE Std 1284-1994 specifies the syntax of a device identifying string which contains the device's vendor and model. Although the Vendor_ID and Model_ID entries defined by IEEE P1212 express equivalent information, PPDT devices may also include a device ID string in their configuration ROM. This clause specifies a uniform method for the inclusion of such a string.

The device ID string, if present, shall be a textual descriptor associated with the Logical_Unit_Number entry in a unit directory. The *width* ~~*character_set*~~ and *language* fields in the textual descriptor shall be zero. The value of the *character set* field shall be three; this indicates that the text string character set is US-ASCII, as specified by ANSI X3.4-1968. The format of the text string shall be as specified by IEEE Std 1284-1994 clause 7.6, except that it shall not commence with two bytes of length.⁶ The text string shall include the MANUFACTURER, MODEL, CLASS and COMMAND SET fields (which may be abbreviated in the text string as MFG, MDL, CLS and CMD respectively).

Multifunction devices shall identify their supported functions *via* multiple values assigned to the CLASS field. If characteristics of a particular function, *e.g.*, the command set, differ from other functions, the CLASSINFO field (which may be abbreviated in the text string as CLI) may be used to associate fields with a particular function. The CLASSINFO field is an extension, created by this standard, to the fields defined by IEEE Std 1284-1994. The syntax of the CLASSINFO field is CLI:*value*; where *value* shall be a function class specified by the CLS field. All fields that follow a CLI field pertain to the class identified by *value* until the next CLI field in the device ID string.

⁶ The length, in bytes, of a textual descriptor's text string may be calculated by subtracting the number of trailing pad (null) characters from $4 * \text{descriptor_length}$.

Annex A (normative)

Minimum Serial Bus node capabilities

In addition to the minimum capabilities defined by IEEE Std 1394-1995, ANSI NCITS 325-1998 and draft standard IEEE P1394a, this annex specifies other capabilities or restrictions mandated by this standard.

A.1 Initiator capabilities

With the exception of configuration ROM and control and status registers, an initiator shall be capable of responding to block read or write requests with a *data_length* less than or equal to 64 bytes.

An initiator shall also be capable of responding to block read requests with a *data_length* less than or equal to $4 * ORB_size$, where *ORB_size* is obtained from the Unit_Characteristics entry in the target's configuration ROM.

For the largest value of *max_payload* specified in any command block ORB it signals to the target, an initiator shall be capable of responding to block read and write requests with a *data_length* less than or equal to $2^{max_payload+2}$ bytes.

An initiator shall report the largest of these possible *data_length* values by setting the value of the *max_rec* field in the bus information block in its configuration ROM to a value equal to or greater than $(\log_2 data_length) - 1$.

A.2 Target capabilities

A target shall be capable of responding to block read or write requests with a *data_length* equal to eight bytes if the *destination_offset* specifies either the MANAGEMENT_AGENT or the ORB_POINTER register.

A target shall be capable of initiating write requests and shall report this by setting the *drq* bit in the Node_Capabilities entry in configuration ROM to one. Consequently, targets shall implement the *drq* bit in the STATE_CLEAR and STATE_SET registers. The value of STATE_CLEAR.*drq* shall be unaffected by a Serial Bus reset. Targets may automatically set *drq* to zero (request initiation enabled) upon a power reset or a command reset.

A target shall be capable of initiating block write requests with a *data_length* of at least 16 bytes.

While initializing after a power reset, a target shall respond to quadlet read requests addressed to FFFF F000 0400₁₆ with either a response data value of zero or acknowledge the request subaction with *ack_tardy*, as specified by draft standard IEEE P1394a. This indicates that the remainder of configuration ROM, as well as other target CSRs, are not accessible.

Targets shall support management request functions addressed to the MANAGEMENT_AGENT register as specified by the table below.

<i>function</i>	Support	Description
0	Mandatory	LOGIN
1	Mandatory	QUERY LOGINS
2	—	Reserved for future standardization
3	Mandatory	RECONNECT
4	Optional	SET PASSWORD (see ANSI NCITS 325-1998 Annex C)
5 – 6	—	Reserved for future standardization
7	Mandatory	LOGOUT
8 – A ₁₆	—	Reserved for future standardization
B ₁₆	Not supported	ABORT TASK
C ₁₆	Mandatory	ABORT TASK SET
D ₁₆	—	Reserved for future standardization
E ₁₆	Not supported	LOGICAL UNIT RESET
F ₁₆	Mandatory	TARGET RESET

Annex B (normative)

Compliance with ANSI NCITS 325-1998

Subsequent to the approval of SBP-2 as an American National Standard, the IEEE P1212 working group commenced a revision of the CSR Architecture. This peer-to-peer data transport protocol, based upon SBP-2, conforms to the more recent recommendations and requirements of draft standard IEEE P1212, some of which conflict with normative requirements of ANSI NCITS 325-1998. This annex lists the points of divergence as well as areas for which this standard specifies SBP-2 implementation constraints not required by ANSI NCITS 325-1998.

B.1 Divergence from ANSI NCITS 325-1998

SBP-2 requires a target to attempt to store unsolicited status for all initiators logged in to a logical if it stores unsolicited status for any initiator logged into that logical unit. This requirement contains an implicit assumption that unsolicited status is pertinent to all initiators logged in to the same logical unit—but in the case of the *attention* bit, the information is relevant to only one initiator. As a consequence, this standard is written as if the first paragraph of 5.3.2 in ANSI NCITS 325-1998 were replaced with the following text:

"When a change in device status occurs that affects a logical unit, the target may store the status block shown in Figure 25 at the *status_FIFO* address provided by the initiator as part of a login request (see 5.1.3.1). If a target stores unsolicited status for any initiator logged-in to a logical unit it should attempt to store unsolicited status for other initiators logged-in to the same logical unit—but only if the unsolicited status information is pertinent to the other initiators."

SBP-2 was drafted before the IEEE P1212 working group started to revise the CSR Architecture, ISO/IEC 13213:1994. New efforts in the working group have rendered the SBP-2 requirement for a Unit Directory entry in the root directory out of date. The revised CSR Architecture permits the SBP-2 legacy approach but it recommends a newer approach that makes unit directories the children of instance directories. This standard follows the more recent recommendations draft standard IEEE P1212 and therefore is not compliant with ANSI NCITS 325-1998.

B.2 Implementation constraints in addition to ANSI NCITS 325-1998

An initiator shall signal ORBs to targets in the same order as they are presented by its application clients and services. An initiator shall report completion status to its application clients and services in the same order as the status block(s) are written to the initiator's *status_FIFO*. These additional requirements are necessary to permit the ordered execution of ORBs within a single queue even though the target reports that it implements the SBP-2 unordered execution model in its configuration ROM.

If an event, such as the abortion of a task set, causes more than one ORB to simultaneously complete, an initiator shall report completion status to its application clients and services in the same order as which the ORBs were signaled to the target.

An initiator shall either permit its application clients and services to control the value of the *notify* bit for individual ORBs or shall set the *notify* bit to one for all ORBs.

Annex C
(normative)

Control request and response parameters

The table below provides a quick reference to the parameters associated with particular control requests and responses; consult section 6 for details for a particular request or response. Optional parameters are shown by parentheses; the last column indicates whether or not the response information may be sent autonomously.

<i>ctrl_function</i>	Name	Requester	Request parameters	Response parameters	Autonomous response
1	CONNECT	Initiator	SERVICE_ID MODE (TASK_SLOTS)	Queue ID(s) ⁷ TASK_SLOTS	No
		Target	Queue ID(s) ³ SERVICE_ID MODE TASK_SLOTS	(TASK_SLOTS)	
2	SHUTDOWN QUEUE	Either	Queue ID	No response allowed	
3	RELEASE QUEUE	Initiator	Queue ID		
4	SERVICE DIRECTORY	Either	—	SERVICE_ID(s)	Permitted
5	STATUS	Initiator	—	QUEUE_INFO	Target only

⁷ At least one queue ID parameter shall be present, either I2T_QUEUE or T2I_QUEUE, and both may be present. In the latter case the two queue ID parameters may identify different queues or the same queue.

Annex D
(normative)

Control and status registers

The control and status registers (CSRs) implemented by a target shall conform to the requirements defined by this standard and its normative references. The CSRs may be arranged in three principal categories:

- core registers defined by draft standard IEEE P1212 and required by either that standard or this document;
- bus-dependent registers required by IEEE Std 1394-1995; and
- unit architecture registers required by ANSI NCITS 325.1998.

The relevant standard shall be consulted for details of register definition and usage; the table below provides a quick reference that summarizes all CSRs used by this document. Except for the optional MESSAGE_REQUEST and MESSAGE_RESPONSE registers, all of the CSRs are mandatory.

Offset	Register name	Description
0	STATE_CLEAR	State and control information
4	STATE_SET	Sets STATE_CLEAR bits
8	NODE_IDS	Contains the 16-bit node_ID value used to address the node
C ₁₆	RESET_START	Resets the node's state
18 ₁₆ – 1C ₁₆	SPLIT_TIMEOUT	Time limit for split transactions
80 ₁₆ – BC ₁₆	MESSAGE_REQUEST	Message area for target requests when no login exists
C0 ₁₆ – FC ₁₆	MESSAGE_RESPONSE	Message area for initiator responses to target requests addressed to MESSAGE_REQUEST.
210 ₁₆	BUSY_TIMEOUT	Controls transaction layer retry protocols
specified by configuration ROM	MANAGEMENT_AGENT	Login and other SBP-2 task management requests
specified by login response data	AGENT_STATE	Reports SBP-2 fetch agent state
	AGENT_RESET	Resets SBP-2 fetch agent
	ORB_POINTER	Address of current ORB
	DOORBELL	Signals SBP-2 fetch agent to refetch an address pointer
	UNSOLICITED_STATUS_ENABLE	Acknowledges the SBP-2 initiator's receipt of unsolicited status

Annex E
(informative)

Configuration ROM

Configuration ROM is located at a base address of FFFF F000 0400₁₆ within a node's address space. The requirements for general format configuration ROM for devices compliant with this standard are specified in section 0. This annex contains illustrations of typical configuration ROM for a variety of devices.

E.1 Bus information block and root directory

Figure E-1 below shows a typical bus information block, root directory and textual descriptor leaves for devices compliant with this standard. Not shown are the instance, feature and unit directories themselves; these may vary according to the complexity of the device and its supported software interfaces. Consult other clauses in this annex for examples of printers, scanners and other (multifunction) devices.

4	9	CRC (calculated)
3133 3934 ₁₆ (ASCII "1394")		
node_options (00FF 6012 ₁₆)		
node_vendor_ID		chip_ID_hi
chip_ID_lo		
4		Root directory CRC (calculated)
03 ₁₆	vendor_ID	
81 ₁₆	Text descriptor leaf offset (3)	
0C ₁₆	node_capabilities (00 83C0 ₁₆)	
D8 ₁₆	Instance directory offset	
3		Text leaf CRC (calculated)
0	specifier_ID (0)	
width (0)	character_set (0)	language (0)
5859 5A00 ₁₆ (ASCII "XYZ ")		

least significant

Figure E-1 – Example bus information block and root directory

The CRC in the first quadlet is calculated on following nine quadlets of configuration ROM, the bus information block and the root directory. Devices should not include all of configuration ROM within the coverage provided by this CRC; the other directories and leaves each contain their own CRC.

The *node_options* field represents a collection of bits and fields specified draft standard IEEE P1212. The value shown, 00FF 6012₁₆, represents basic characteristics of a device that is not isochronous capable.

This value is composed of a *cyc_clk_acc* field with a value of FF₁₆, a *max_rec* value of six, a *max_ROM* value of one and a *link_spd* value of two. The *max_rec* field encodes a maximum payload of 64 bytes in block write requests addressed to the target.

The *Node_Capabilities* entry in the root directory, with a *key* field of 0C₁₆, has a value where the *spt*, *64*, *fix*, *lst* and *drq* bits are all one. This is a minimum requirement for devices compliant with this standard.

The *Vendor_ID* entry in the root directory, with a *key* field of 03₁₆, is immediately followed by a textual descriptor leaf entry, with a *key* field of 81₁₆, whose *indirect_offset* value points to a leaf that contains an ASCII string that identifies the vendor (the XYZ company). Although the textual descriptor leaf utilizes minimal ASCII, a permissible variant might include a textual descriptor directory in order to provide multiple language support.

The *Instance_Directory* entry in the root directory, with a *key* field of D8₁₆, is the starting point for device discovery (enumeration) software to search configuration ROM for particular function instances.

E.2 Feature directory

Devices compliant with this standard implement a feature directory for each instance. An example of a feature directory, with its associated service ID and device ID leaves is illustrated by Figure E-2. Except for these generic features, additional content of the feature directory is device-dependent; see 8.3 for more details on the other directory entries that may be present.

most significant	4	Feature directory CRC (calculated)
12 ₁₆	specifier_ID (00 5029 ₁₆)	
13 ₁₆	version	
B0 ₁₆	Service ID leaf offset (1)	
B1 ₁₆	Device ID leaf offset (2)	
1	Service ID leaf CRC (calculated)	
53 5643 ₁₆ (ASCII "SVC")		0
3	Text leaf CRC (calculated)	
spec_type (0)	specifier_ID (0)	
language_ID (0)		
5151 5151 ₁₆ (ASCII "QQQQ")		
least significant		

Figure E-2 – Feature directory with service ID and device ID leaves

The *Specifier_ID* and *Version* entries, with a *key* field of 12₁₆ and 13₁₆, respectively, indicate that the format of the unit directory is specified by this document.

The *Service_ID* entry, with a *key* field of B0₁₆, points to the service ID leaf, which is in the same format as keyword leaves. The service ID leaf specifies a hypothetical service identified as "SVC".

The Device_ID entry, with a key field of B1₁₆, points to a textual descriptor leaf that contains an ASCII string that identifies the device to bus enumeration software.

E.3 Unit directory

Targets compliant with this standard implement at least one unit directory in the format illustrated by Figure E-3. Devices that support more than one software protocol (unit architecture) may implement additional unit directories whose format is specified by other documents.

3	Unit directory CRC (calculated)
12 ₁₆	specifier_ID (00 609E ₁₆)
13 ₁₆	version (01 0483 ₁₆)
38 ₁₆	command_set_spec_ID (00 5029 ₁₆)
39 ₁₆	command_set (0)
54 ₁₆	csr_offset (00 4000 ₁₆)
3A ₁₆	Unit characteristics (00 0A08 ₁₆)
14 ₁₆	Device type and LUN (0)
9A ₁₆	Feature directory offset

least significant

Figure E-3 – Unit directory for peer-to-peer data transport (PPDT) protocol target

The Specifier_ID and Version entries, with a key field of 12₁₆ and 13₁₆, respectively, indicate that the format of the unit directory is specified by ANSI NCITS 325-1998.

The Command_Set_Spec_ID and Command_Set entries, with key fields of 38₁₆ and 39₁₆, respectively, indicate that the target use the peer-to-peer data transport (PPDT) protocol specified by this document..

The Management_Agent entry in the unit directory, with a key field of 54₁₆, has a csr_offset value of 00 4000₁₆ that indicates that the management agent CSR has a base address of FFFF F001 0000₁₆ within the node's memory space.

The Unit_Characteristics entry in the unit directory, with a key field of 3A₁₆, has an immediate value of 00 0A08₁₆. This indicates a target that is expected to complete task management requests (including login) within five seconds and fetches 32-byte ORB's.

The Logical_Unit_Number entry in the unit directory, with a key field of 14₁₆, has an immediate value of zero that indicates a device that may reorder tasks without restriction and has a logical unit number of zero.

At least one Feature_Directory entry is present; it addresses the same feature directory as the parent instance directory for this unit. See Figure E-2 for an example of a typical feature directory.

E.4 Scanner with a single unit architecture

The configuration ROM for a simple device, such as a scanner, that implements only one software protocol (unit architecture) utilizes the bus information block and root directory structure already described in Figure E-1. An example instance directory and its associated keyword leaf is illustrated by Figure E-4.

3		Instance directory CRC (calculated)	
99 ₁₆	Keyword leaf offset (2)		
DA ₁₆	Feature directory offset		
D1 ₁₆	Unit directory offset		
4		Keyword leaf CRC (calculated)	
43 ₁₆ ("C")	4F ₁₆ ("O")	4C ₁₆ ("L")	4F ₁₆ ("O")
52 ₁₆ ("R")	0	53 ₁₆ ("S")	43 ₁₆ ("C")
41 ₁₆ ("A")	4E ₁₆ ("N")	4E ₁₆ ("N")	45 ₁₆ ("E")
52 ₁₆ ("R")	0	0	

least significant

Figure E-4 – Instance directory and keyword leaf for a scanner

The Keyword_Leaf entry, with a *key* value of 99₁₆, points to a keyword leaf that contains the keywords COLOR and SCANNER.

Since this is a simple device that supports a single software protocol (unit architecture), there is only one Unit_Directory entry, with a *key* value of D1₁₆, in the instance directory.

E.5 Printer with multiple unit architectures

The configuration ROM for a more complex device, such as a printer that implements more than one software protocol (unit architecture) also utilizes the bus information block and root directory structure already described in Figure E-1. An example instance directory and its associated keyword leaf is illustrated by Figure E-5.

most significant			
4		Instance directory CRC (calculated)	
99 ₁₆		Keyword leaf offset	
DA ₁₆		Feature directory offset	
D1 ₁₆		Unit directory offset (PPDT protocol)	
D1 ₁₆		Unit directory offset (DPP)	
6		Keyword leaf CRC (calculated)	
50 ₁₆ ("P")	48 ₁₆ ("H")	4F ₁₆ ("O")	54 ₁₆ ("T")
4F ₁₆ ("O")	0	50 ₁₆ ("P")	52 ₁₆ ("R")
49 ₁₆ ("I")	4E ₁₆ ("N")	54 ₁₆ ("T")	45 ₁₆ ("E")
52 ₁₆ ("R")	0	44 ₁₆ ("D")	50 ₁₆ ("P")
50 ₁₆ ("P")	0	53 ₁₆ ("S")	42 ₁₆ ("B")
50 ₁₆ ("P")	2D ₁₆ ("-")	32 ₁₆ ("2")	0
		least significant	

Figure E-5 – Instance directory and keyword leaf for a multiple protocol printer

The Keyword_Leaf entry, with a key value of 99₁₆, points to a keyword leaf that contains the keywords PHOTO, PRINTER, DPP and SBP-2.

Since this target supports multiple software protocols (unit architectures) for the same physical instance of the print engine, there are two Unit_Directory entries in the instance directory, one that references a unit directory compliant with this standard and one that references a Direct Print Protocol (DPP) unit directory.

E.6 Multifunction device with uniform unit architectures

EDITOR'S NOTE – Has the 1394 PWG reached consensus as to what this example should show—or even if it will be intelligible to the average reader?