

---

# 1284.4 Over SBP2 Concept Proposal



- Overview
- Login
- Fetch Agent
- 1394 Transactions
- Status
- Summary
- 1284.4 over SBP2 and Microsoft



**1394 PWG**

# 1284.4 Over SBP2 Overview

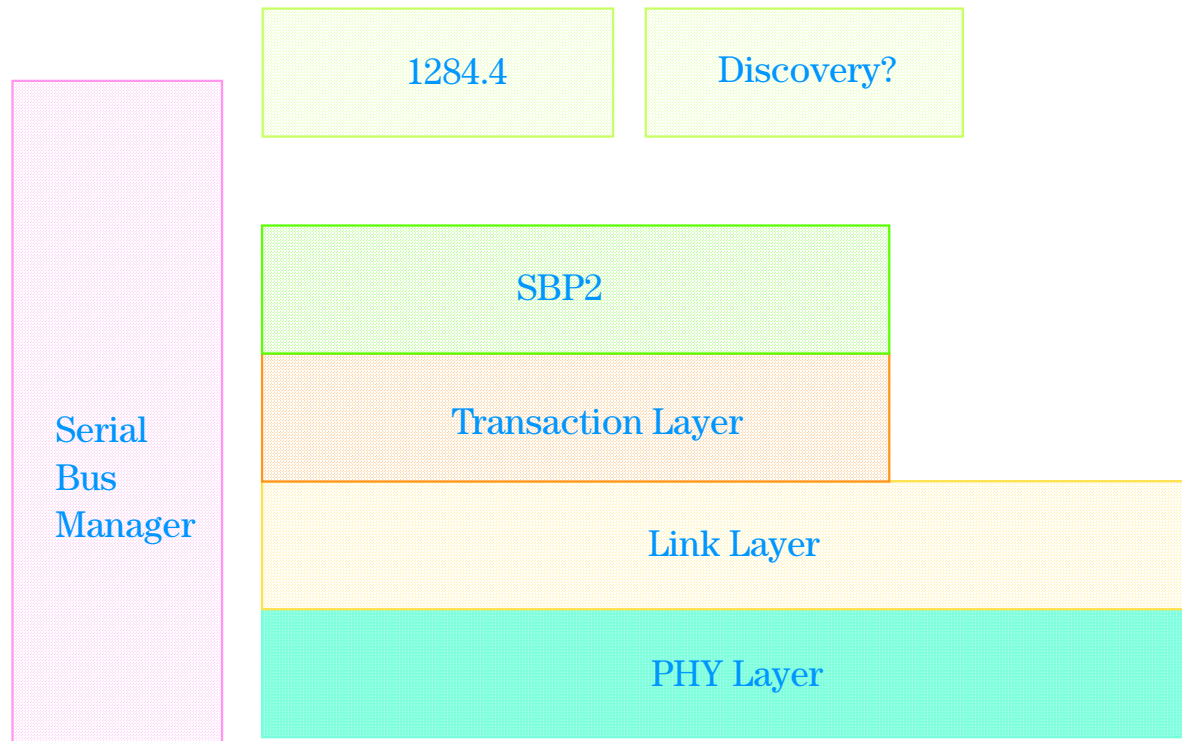

---

# 1284.4 Over SBP2

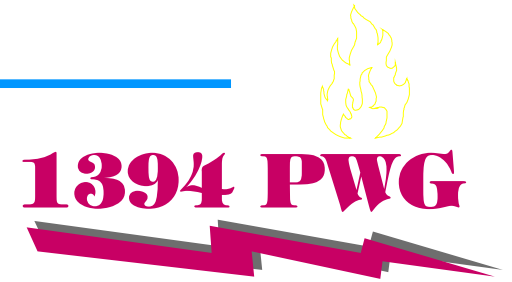

- Use SBP Terminology for Describing the Transport Layer
- Initiator == Source
- Target == Sink



**1394 PWG**



# 1284.4 Over SBP2 Login

- Initiator reads the address of the Management\_Agent Register out of Target Config ROM.
- Initiator attempts 1394 Write request to the Targets Managment\_Agent Register. The Write Contains the address of the managment ORB.
- The Target will then Fetch the Login ORB.
- See spec. for Validation and Resource availability

Login ORB

Password (Address)	
Login_Response (Address)	
	LUN
Password_Len	Login_Response_Len
Status Fifo (Address)	

Login Response

Length	Login_ID
Command_Block_Agent (Address)	



**1394 PWG**



# 1284.4 Over SBP2 Login - Command Block Agent

Command\_Block\_Agent Address is in Config ROM Space, greater than  
FFFF F001 0000h

Relative Offset	Name	Description
00h	Agent State	Reports fetch agent state
04h	Agent_Reset	Resets fetch Agent
08h	ORB_Pointer	Address of ORB
10h	Doorbell	Signals fetch agent to refetch Address
14h	Unsolicited_Status_Enable	Acknowledge receipt of Uns. Status
18h - 1Ch		Reserved



**1394 PWG**

# 1284.4 Over SBP2 Fetch Agent

Initiator

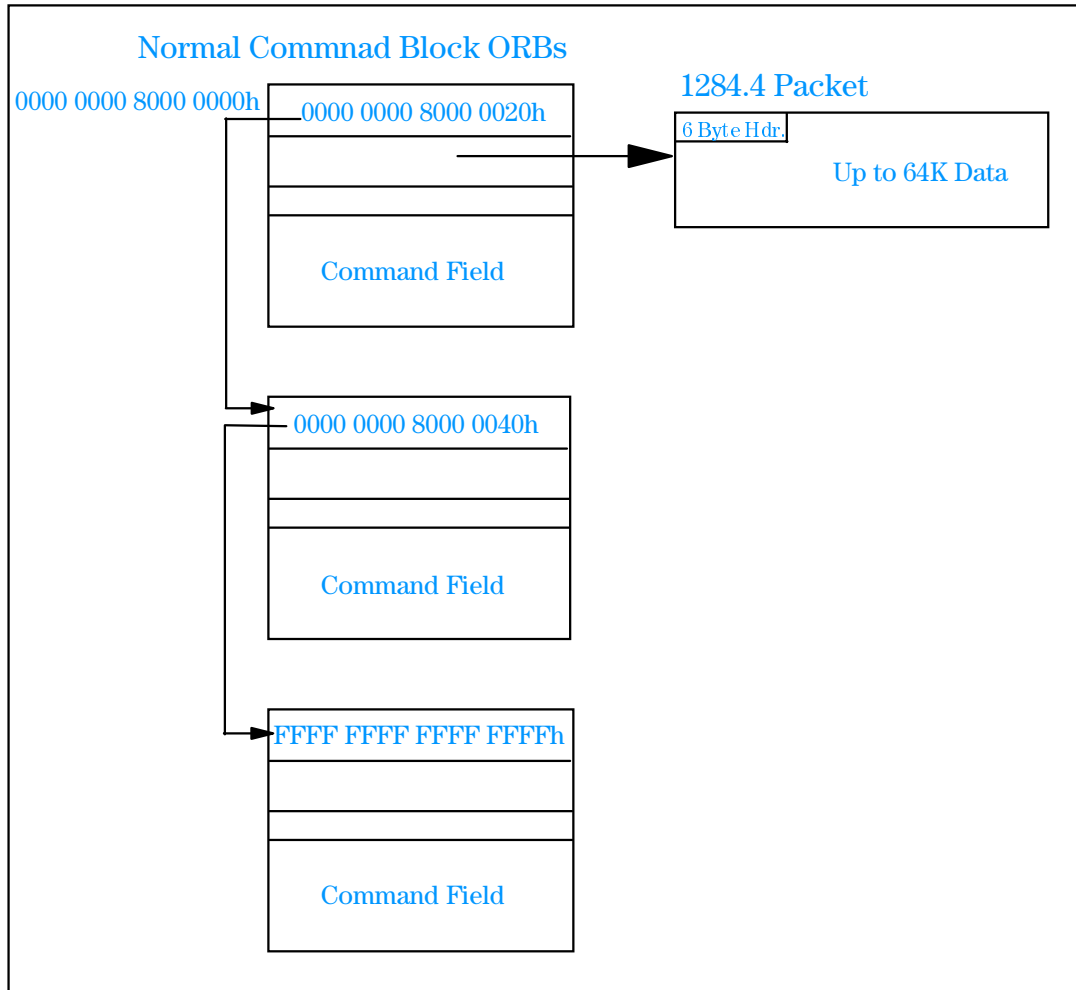

Target

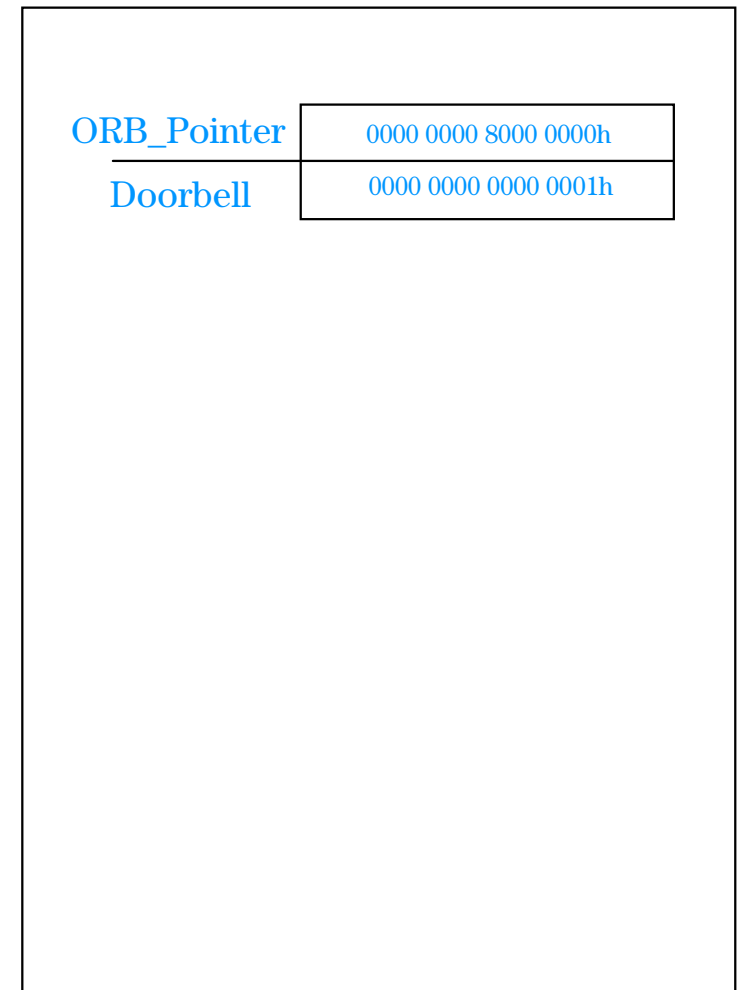



**1394 PWG**



# 1284.4 Over SBP2 1394 Actions

Initiator

Target

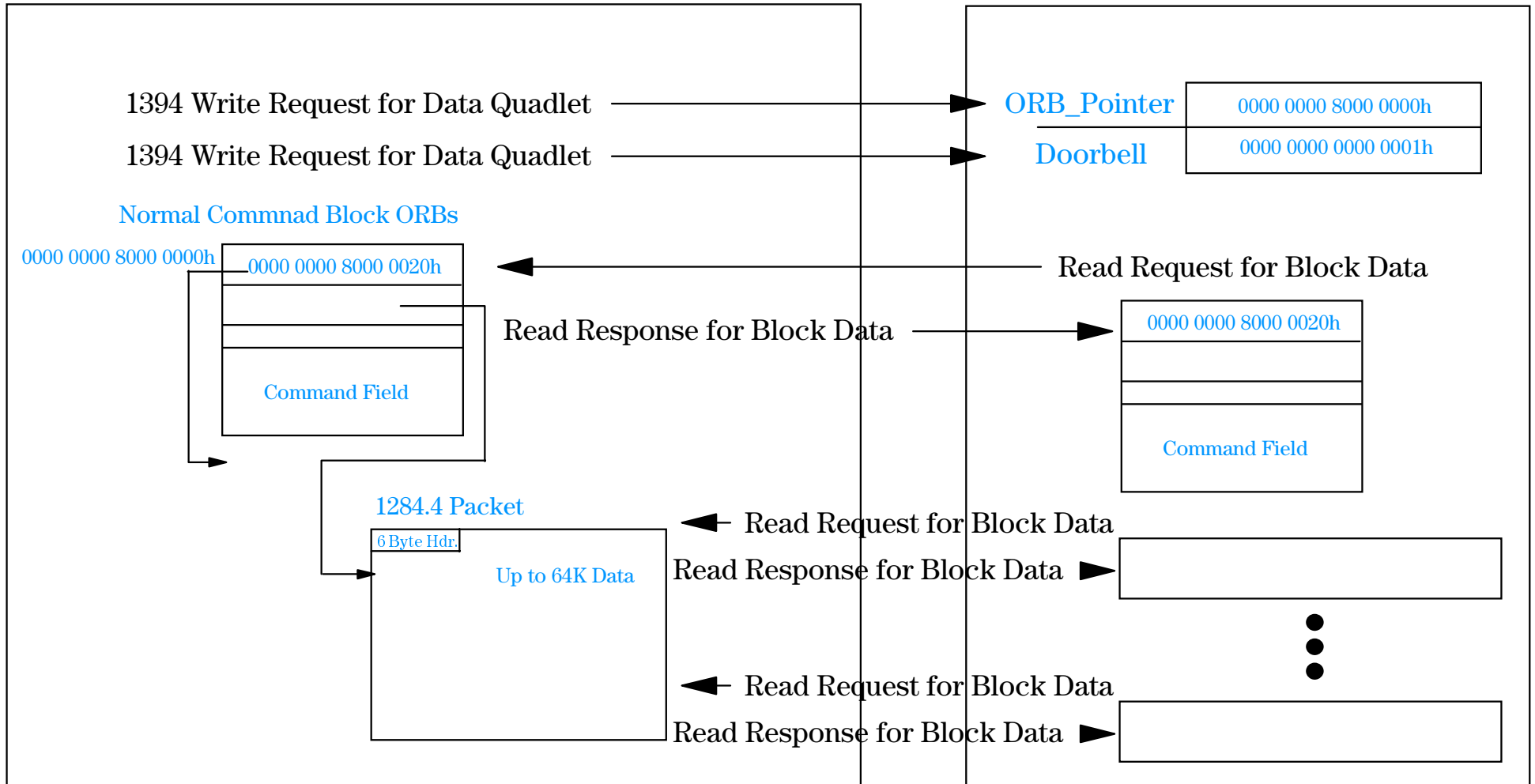

# 1284.4 Over SBP2 Command Block Status

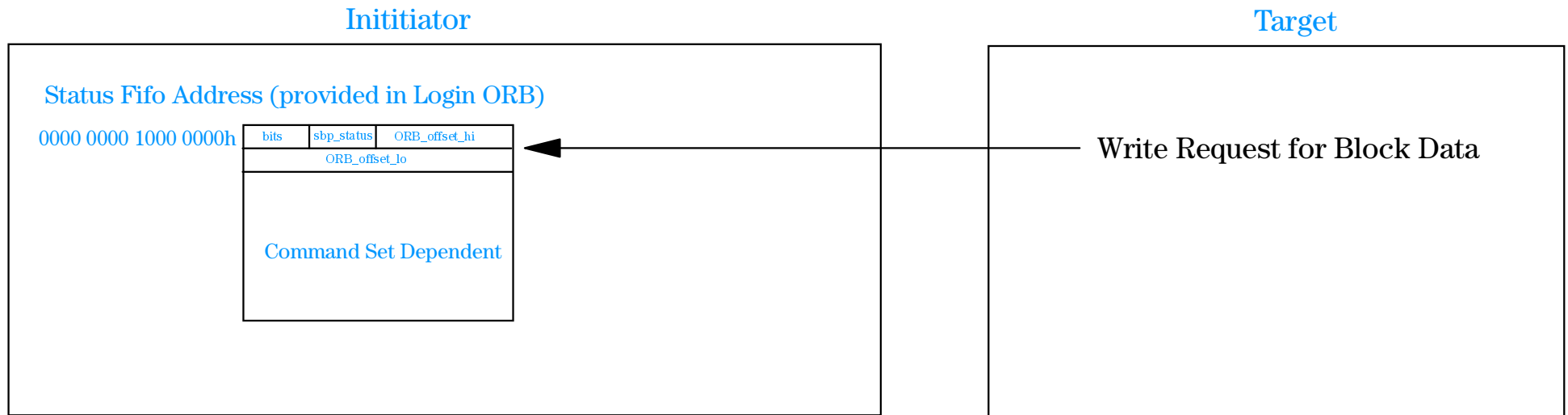
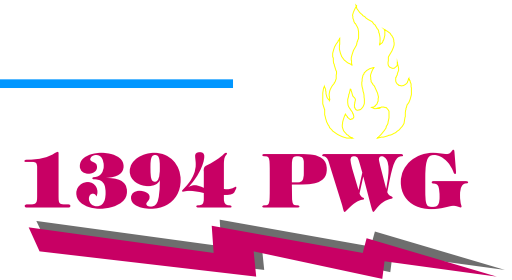

- If we use the Status Fifo Address we should stop executing this task until the Initiator has read the status (how do we know?) to avoid over writing it with Status from the next ORB.
- Another way to do this is to explicitly provide a separate Status Block Address in the Command Block ORB





**1394 PWG**



# 1284.4 Over SBP2 Unsolicited Status

Initiator

Target

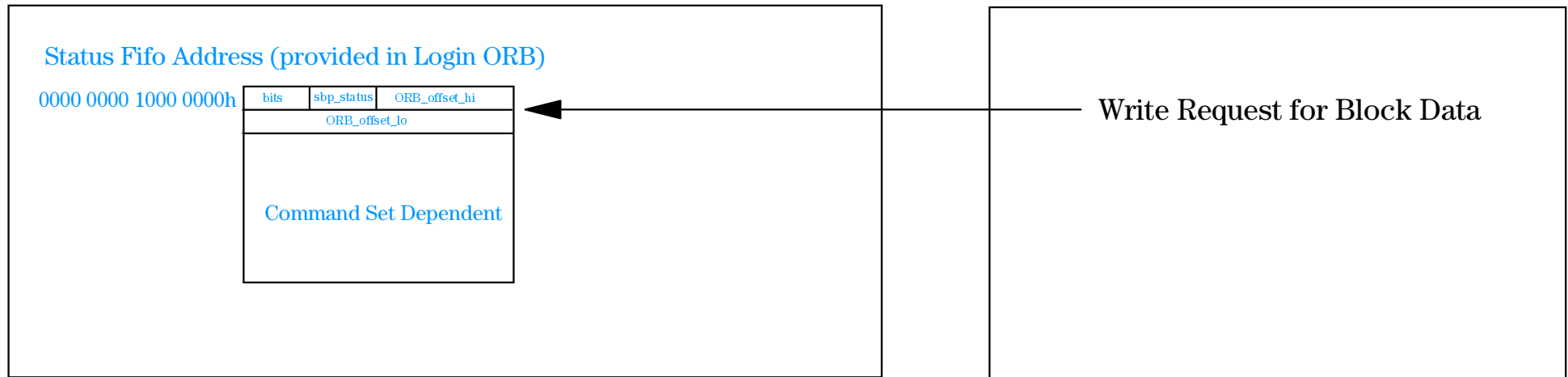

- After the Target writes the Status block, it clears the Unsolicited\_Status\_Enable bit in the Command Block Agent CSR.
- It cannot write new status until the Initiator sets the Unsolicited\_Status\_Enable bit.

---

# 1284.4 Over SBP2 Summary

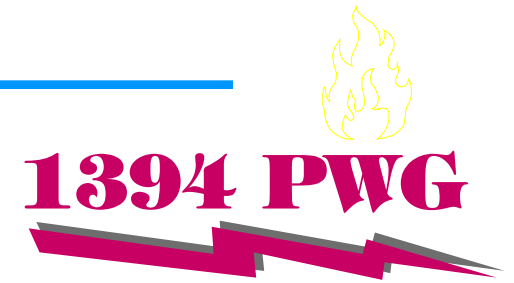

- Uses Existing Standards
- SBP Definitions for Login, Data Transfer etc.
- SBP2 Standardization of Config ROM Space
- Can we use existing 1284.4 Drivers above SBP2?

---

# 1284.4 Over SBP2 1284 Issues

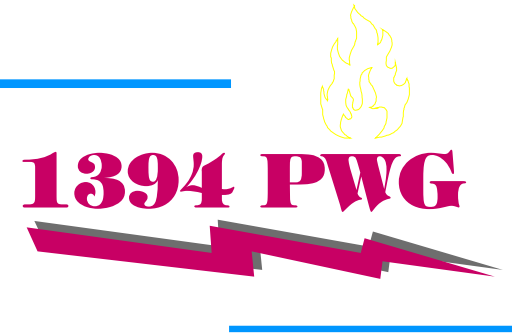

- How do we do 1284.4 back channel data?

# 1284.4 Over SBP2 and Microsoft WDM?

